



YOUR GAME. OUR BUSINESS.™
SPORTS EQUIPMENT PRODUCT CATALOG

GARED® services the after-market, retail, and custom gymnasium structure markets, and have become the leader in innovative product design, precision engineering, and premium manufacturing of sports equipment. Our centrally located manufacturing and warehouse facilities, and new state-of-the-art powder coating operation in Noblesville, Indiana have enabled us to offer our customers shorter lead times and more economical shipping costs. We sell our products through a trusted network of dealers across the United States and around the world.



GARED

Gared Holdings Company

GARED® is a supporting member of many prominent domestic organizations as well as international governing bodies for sports. In addition, our products meet the safety guidelines of the Consumer Product Safety Commission (CPSC), and we continually strive to lower our carbon footprint through sustainable design and recycling of raw materials. **GARED®** is a member of the GARED Holdings, LCC family of brands along with industry-leading brands: **GARED®** Hoops, **GARED INTERNATIONAL**, and **PERFORMANCE SPORTS SYSTEMS®**.

Much has changed in sports over the years since our establishment in 1922. Games are now faster, more intense, and competitive. As the games have changed, **GARED®** has met these challenges, by constantly improving the design, strength and durability of our sports equipment. We continue to build on past expertise while shaping the future of the sports that we serve. Our sports equipment is found in a variety of venues; in pro-arenas and universities across the world, school yards, parks, high school gymnasiums, both in big cities and small towns, and in the driveways and home courts of people who recognize the value of reliability and product quality.

DON'T STAND ON THE SIDELINES – GET IN THE GAME WITH GARED!

ABOUT PLAYRX

For over ninety years GARED has set the standard for the manufacturing of athletic equipment. Whether in a school gymnasium, city park, or recreation center - sports equipment that is in good working condition benefits players, fans, and communities alike. It has a nicer appearance and encourages better play - keeping everyone coming back for more! As play environment experts we want to help you keep your play environments safe and inviting for all your players. In order to help accomplish this we created the **PlayRX®** program which consists of two levels: self evaluation inspection or certified inspection.



LEVEL ONE is a GARED guided visual inspection of your play environment through the means of our equipment checklist. Don't risk the safety and enjoyment of your players and fans by providing them with poorly-operating equipment. Our checklist provides you with our decades of experience of what and where to look for common problems that can plague your athletic equipment. Then through an easily calculated score card, we help you determine if replacement or further inspections is required for your equipment. As we all know an ounce of prevention is worth a pound of cure so early diagnosis is critical to keeping your court or field ready for play!

LEVEL TWO is the answer when further diagnosis or replacement is required. Look no further than GARED's factory certified, thoroughly experienced, **PlayRX® DEALER NETWORK** for assistance! Let GARED guide you to the local representative to help you solve your problems by recommending one of these GARED tested and approved representatives in your area to help you fix those athletic equipment ills that are beyond your facilities capabilities.

Regardless of your equipment's age, origin, or level of disrepair, GARED's PlayRX® program has your remedy.

GARED HAS YOUR PRESCRIPTION FOR FUN!

GYMNASIUM EQUIPMENT**4 - 21**

CEILING HUNG CUSTOM BACKSTOPS	6 - 7	MULTI-SPORT, BATTING & THROWING CAGES	16 - 17
WALL MOUNT BACKSTOPS	8 - 9	WALL PADS	18 - 19
GYMNASIUM ACCESSORIES	10 - 11	TOTAL GYMNASIUM CONTROLS	20
DIVIDER CURTAINS	12 - 15	CLIMBING ROBES, CHIN UP BARS & LADDERS	21
MAT CARRIER SYSTEMS	16		

PORTABLE BASKETBALL BACKSTOPS**22 - 33**

GARED PRO® SPRING PORTABLE BACKSTOP	24 - 25	ROLL AROUND PORTABLE BACKSTOPS	31
GARED PRO® HYDRAULIC PORTABLE BACKSTOP	26 - 27	SPACE JAM™ TOURNAMENT BACKSTOPS	32
HOOPMASTER® PORTABLE BACKSTOP	28	PORTABLE BACKSTOP UPGRADES	33
HOOPMASTER® LT PORTABLE BACKSTOP	29	QUICK CONNECT™ CART SYSTEM	33
RECREATIONAL PORTABLE BACKSTOPS	30		

OUTDOOR BASKETBALL SYSTEMS**34 - 45**

OUTDOOR PORTABLE BACKSTOPS	36 - 37	ENDURANCE® PLAYGROUND SYSTEMS	42
GOOSENECK & ADJUSTABLE ARM POSTS	38	ADJUSTABLE PLAYGROUND SYSTEMS	43
PLAYGROUND ECONOMY PACKAGES	39	OUTDOOR BASKETBALL ACCESSORIES	44 - 45
PLAYGROUND STANDARD DUTY PACKAGES	40		
PLAYGROUND HEAVY DUTY PACKAGES	41		

BASKETBALL EQUIPMENT**46 - 61**

COMPETITION GLASS BACKBOARDS	48	PRO-MOLD® BACKBOARD PADDING	54 - 55
BUZZER BEATER™ PERIMETER LED LIGHTS	49	BREAKAWAY COMPETITION RIMS	56 - 57
GYMNASIUM EASY BUY PACKAGES	49	RECREATIONAL PLAYGROUND RIMS	57 - 59
SPECIALTY GLASS BACKBOARDS	50	BASKETBALL NETS & TRAINING AIDS	60 - 61
NON-GLASS & OUTDOOR BACKBOARDS	50 - 53		

VOLLEYBALL & NET SPORTS**62 - 83**

SKYMASTER® CEILING HUNG VOLLEYBALL SYSTEM	64 - 65	SITTING VOLLEYBALL SYSTEM	73
GO COURT™ PORTABLE VOLLEYBALL SYSTEMS	66 - 67	SAND VOLLEYBALL SYSTEMS	74 - 75
LIBERO™ 4" VOLLEYBALL SYSTEMS	68 - 69	VOLLEYBALL PADS & REFEREE STANDS	76
RALLYLINE™ 3 1/2" VOLLEYBALL SYSTEMS	70 - 71	VOLLEYBALL FLOOR SLEEVES, NETS & ACCESSORIES	76 - 79
OMNISTEEL™ 3" VOLLEYBALL SYSTEM	72	BADMINTON, NETBALL, FUTSAL & HANDBALL	80 - 81
3" VOLLEYBALL ALUMINUM SYSTEM	73	TENNIS & TETHERBALL	82 - 83

FIELD SPORT EQUIPMENT**84 - 95**

TOUCHLINE STRIKER™ SOCCER GOALS	86	FIELD FORCE™ NETTING SYSTEMS	91
TOUCHLINE™ PREMIUM SOCCER GOALS	87	SOCCER TRAINING AIDS	92
TOUCHLINE™ CLUB & PRACTICE SOCCER GOALS	88 - 89	CAMOGIE, FIELD HOCKEY, FUTSAL & FIELD HOCKEY	93
ALL STAR FIFA SOCCER GOAL	89	SLINGSHOT™ LACROSSE GOALS & ACCESSORIES	94
SOCCER NETS, ACCESSORIES & SCOREBOARDS	89 - 91	REDZONE™ FOOTBALL GOALPOSTS & ACCESSORIES	95

FIELD & SITE AMENITIES**96 - 109**

SPECTATOR™ SERIES TIP N' ROLL BLEACHERS	98 - 99	SPECTATOR™ SERIES BLEACHER COMPONENTS	105
SPECTATOR™ SERIES STATIONARY BLEACHERS	100 - 101	SPECTATOR™ SERIES BENCHES	106
SPECTATOR™ SERIES LOW RISE BLEACHERS	102	SPECTATOR™ SERIES BIKE RACKS	107
SPECTATOR™ SERIES TRANSPORTABLE BLEACHERS	103	BASEBALL & SOFTBALL OUTDOOR BATTING CAGES	108
SPECTATOR™ SERIES CUSTOM BLEACHERS	104	BASEBALL & SOFTBALL FIELD FOUL POLE & AMENITIES	109

GARED REFERENCES**110 - 111**

PRODUCT INDEX

110 - 111

BLOG: [HTTP://PLAYRXBYGARED.BLOGSPOT.COM/](http://playrxbygared.blogspot.com/)FACEBOOK: [WWW.FACEBOOK.COM/GARED1922](http://www.facebook.com/gared1922)INSTAGRAM: [GARED.1922](http://gared.1922)LINKEDIN: [GARED SPORTS](http://garedsports)PINTEREST: [WWW.PINTEREST.COM/GARED1922/](http://www.pinterest.com/gared1922/)TUMBLR: [//PLAYRXBYGARED.TUMBLR.COM/](http://playrxbygared.tumblr.com/)TWITTER: [@GAREDSPORTS](http://@garedsports)YOUTUBE: [WWW.YOUTUBE.COM/USER/1922GARED](http://www.youtube.com/user/1922gared)

ALL GARED MARKETING IMAGES & DESCRIPTIONS AVAILABLE ON OUR DROPBOX



GYMNASIUM EQUIPMENT

We are the source for engineered quality and superior manufacturing for your architectural showcases. Since 1922, GARED has been supplying the architectural community with superior athletic equipment focusing on quality and customer satisfaction. Our innovative approach to gymnasium construction and design layout functionality provide designers unequalled options and solutions to accommodate the varying needs in sports facilities. Our philosophy of “going the extra mile” ensures our products surpass the expectations set by other sports equipment manufacturers and solidifies our position as a supplier of choice for athletic arenas today. Our staff of engineers are dedicated to new product development, innovation, and continuous improvements, while making safety foremost in our product designs. We partner with local distributors to maintain high levels of customer contact, availability, and personal service and support. All of our dealers are product certified and required to use factory PlayRX certified installers.





CUSTOM BASKETBALL BACKSTOPS ADJUSTABLE MAST HANGER

Engineered hangers designed for strength and safety at critical attachment points provide unequalled performance and reliability.

CHANNEL SUPPORT

4" structural steel top spreader supports our welded frames design allowing the weight of the backstop to assist with the locking of the brace.

OFFSET DESIGN

Our vertical support mast has an offset design allowing the weight of the backstop to assist with the locking of the brace.

FULLY WELDED FRAME

All single post designs under 31' incorporate a 6 5/8" diameter vertical support mast with fully welded frame for maximum rigidity • The mast is stabilized by rectangular tube side sway braces welded to the support channel and the mast • The sways are precision cut to match up perfectly to the vertical mast and horizontal top channel.

DIRECT GOAL ATTACHMENT

All designs incorporate a direct goal mount feature to distribute all stress or load on the goal directly to the vertical support mast • Basketball backstops utilizing this feature are backed by a lifetime backboard warranty.

POWDERCOAT FINISH

All steel has a high quality baked on powdercoat finish • Semi-gloss is our standard color, custom colors available • Colors shown below.

We offer many options to provide each facility designer choices to best meet the needs and requirements of their customer • Our engineers have developed high performance equipment with structural integrity and versatility for all levels of competition.

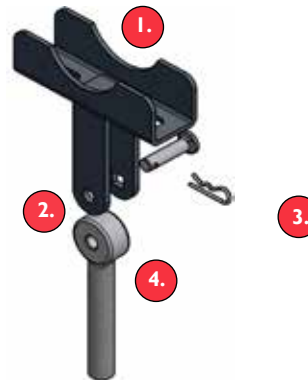

1. 50% MORE WELD THAN THE COMPETITION

2. 1" WIDE BEARING SURFACE, TWICE AS MUCH AS THE COMPETITION

3. 1/2" DIAMETER NON-ROTATING PIN

4. 7/8" DIAMETER FORGED STEEL THREADED HANGER

TESTED STRUCTURAL DESIGN STRENGTHS:

UNEQUALED STRENGTH AND SAFETY

FIBA Certification – All single post backstops have been tested and approved by FIBA, meeting the requirements of stability and safety • Contract No • NP36-2007

SEISMIC TESTING

Our equipment and hardware design have been approved by the state of California, meeting or exceeding all seismic testing requirements.

OVERHEAD DESIGN HARDWARE

Clean overhead designs are built to accommodate many building conditions, while providing the strength to support the load of the equipment and the stress caused by years of competitive use.



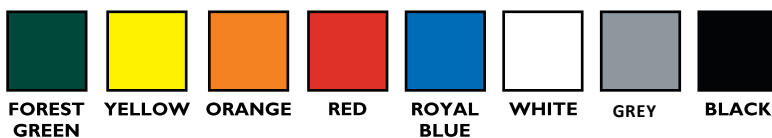







CEILING HUNG BACKSTOP POWDERCOAT COLORS



FIBA
EQUIPMENT
& VENUE

FIBA (Fédération Internationale de Basketball) hereby declares, by means of certification, that **GARED'S CEILING SUSPENDED MODELS 3102; 3103; 3104; 3105; 3106; 3107; 3108; 3109; 3111; 3115** fulfills the Competition Level II standards specified in the latest edition of the Equipment & Venue Approval Programme and **GARED** is therefore qualified as an **OFFICIAL TECHNICAL PARTNER. (CONTRACT NUMBER: P04-2015)**

PLAYRX™ SINGLE POST CEILING STRUCTURES PRODUCT GUIDE

MODEL NUMBER	MODELS 3103/3102/3102HD	MODELS 3105/3104/3104HD	MODELS 3107/3106/3106HD	MODELS 3109/3108/3108HD	MODEL S 3111/3110/3110HD
STRUCTURE					
DESIGN APPLICATION	Best for facilities with adequate space behind the backboard to brace the structure and no obstructions or clearance issues in front of the structure • This design offers maximum clearance above the court.	Great choice for those facilities with clearance issues over the court that will not allow front fold design, yet offers adequate space behind the backstop to allow rear folding for storage	Best used in facilities designed without adequate space behind the backstop structure for rear bracing, and with no clearance issues over the court for front bracing to fold forward and up for storage.	This model is the perfect solution for the fieldhouse or gymnasium with large amounts of equipment, and limited space behind the backboard and/or other conditions that don't allow front fold, but still require folding the backstop up to a stored position.	Non-folding design with ceiling brace for those projects not requiring backstops to be moved and will not allow bracing to the wall.
BRACE DIR	REAR BRACED	REAR BRACED	FRONT BRACED	SIDE BRACED	FRONT CEILING BRACED
FOLD DIR	FORWARD FOLD	REAR FOLD	FORWARD FOLD	SIDE FOLD	STATIONARY
MAST TYPE	SINGLE	SINGLE	SINGLE	SINGLE	SINGLE
MAXIMUM & MINIMUM HEIGHT RESTRICTIONS BY MODEL					
31' MAX, 18' MIN	3103	3105	3107	3109	3111
32' MIN	3102/3102HD	3104/3104HD	3106/3106HD	3108/3108HD	3110/3110HD
MAST CONSTRUCTION BY MODEL					
WELDED	3103	3105	3107	3109	3111
CLAMPED	3102, 3102HD	3104/3104HD	3106/3106HD	3108/3108HD	3110/3110HD
MODEL NUMBER	MODELS 3205/3204/3204HD	MODEL 3305	MODEL 3207, 3206, 3206HD	MODEL 3209/3208/3208HD	MODELS 3115/3114/3114HD
STRUCTURE					
DESIGN APPLICATION	A bent single post rear braced rear folding design which reduces the space required behind the backstop for the brace.	A compact design that utilizes a track system to move the backstop forward as it is raised up and back, great for those facilities lacking space for a standard backfold and clearance issues for a standard front fold backstop.	A bent single post front braced forward fold design which reduces the space required in front of the backboard for the brace.	A bent single post side braced side folding design which reduces the space required to the side of the backstop for the brace	Non-folding backstop design with rear wall brace for those projects not requiring backstops to be moved • Maximum distance from wall to face of backboard is 14'.
BRACE DIR	BENT REAR BRACED	REAR BRACED	BENT FRONT BRACED	BENT SIDE BRACED	REAR CEILING. REAR WALL BRACED
FOLD DIR	REAR FOLD	ROLL FOLD	FORWARD FOLD	SIDE FOLD	STATIONARY
MAST TYPE	SINGLE	SINGLE	SINGLE	SINGLE	SINGLE
MAXIMUM & MINIMUM HEIGHT RESTRICTIONS BY MODEL					
31' MAX, 18' MIN	3205	3305	3207	3209	3115
32' MIN	3204, 3204HD		3206/3206HD	3208/3208HD	3114/3114HD
MAST CONSTRUCTION BY MODEL					
WELDED	3205	3305	3207	3209	3115
CLAMPED	3204, 3204HD		3206/3206HD	3208/3208HD	3114/3114HD

WHEN CHOOSING THE RIGHT WALL MOUNT FOR YOUR FACILITY THERE ARE SEVERAL FACTORS TO CONSIDER INCLUDING: pre-existing structures or equipment, facility gymnasium space, condition of facility walls and budgetary constraints. Our telescopic, modular design allows installation ease and "quick ship" policy. GARED offers a full line of basketball wall mounts to customize your space for an optimal and safe play environment.



2350-3040

THREE-POINT WALL MOUNT

GARED'S THREE-POINT WALL MOUNT SYSTEM provides the strongest wall mount structure available for facilities with budget constraints • Incorporates direct-goal attachment that transfers the load of heavy play through the backboard to the structure • 5/0 upper safety chains with heavy malleable turnbuckles provide additional support • Telescopic design allows for complete adjustability and ease of installation • Structural wood mounting pads included • Mounting hardware provided by others • Board and goal are not included unless wall mount package is purchased • Not compatible with 60" front mount or rear mount backboards • Height adjuster is optional.

2350 SERIES: THREE POINT STATIONARY WALL MOUNT SERIES

WEIGHT: VARIES, TRUCK, FREIGHT CLASS 70, 48 HOUR SHIP

- Stationary non-folding unit
- Standard extension length available: 2' - 12'

FOUR-POINT WALL MOUNT SERIES

GARED FOUR-POINT WALL MOUNT SYSTEMS incorporate four point attachment for backboards with 36" x 63" or 20" x 35" mounting centers • 5/0 upper safety chains with heavy malleable turnbuckles provide additional support • Telescopic design allows for complete adjustability and ease of installation • Structural wood mounting pads included • Mounting hardware provided by others • Board and goal are not included unless wall mount package is purchased • Not compatible with 60" front mount backboards • Height adjuster is optional.

2300 SERIES: FOUR-POINT STATIONARY WALL MOUNT SERIES

WEIGHT: VARIES, TRUCK, FREIGHT CLASS 70, 48 HOUR SHIP

- Stationary non-folding unit
- Offers the ability to mount around any obstructions
- Offers a direct goal attachment when height adjuster is purchased
- Standard extension length available: 2'-12'
- Custom extension lengths of 13'-16' available - allow 4-6 weeks for delivery.

2400 SERIES: FOUR-POINT FOLD UP WALL MOUNT SERIES

WEIGHT: VARIES, TRUCK, FREIGHT CLASS 70, 48 HOUR SHIP

- Stores in fold-up vertical, compact position against wall to prevent interference with other court activities.
- In play position, unit locks into stationary 4 point position
- Includes manual winch with crank handle; electric hoist and safstop are optional
- Offers a direct goal attachment when height adjuster is purchased
- Standard extension length available: 4'-12'.

2500 SERIES: FOUR-POINT SIDE FOLD WALL MOUNT SERIES

WEIGHT: VARIES, TRUCK, FREIGHT CLASS 70, 48 HOUR SHIP

- Stores in side fold, horizontal position against wall to prevent interference with other court activities.
- In play position, unit locks into stationary four point position
- Allow 14"-18" between wall mount in stored position and wall, depending on extension length.
- Offers a direct goal attachment when height adjuster is purchased
- Standard extension length available: 4'-12'
- Electric operation (Model 2500-E) is available as option
- Custom extension lengths of 13'-16' available - allow 4-6 weeks for delivery.



2400-9124



2300-3044



2500-3040



2500-4064



FIBA
EQUIPMENT
& VENUE

FIBA (Fédération Internationale de Basketball) hereby declares, by means of certification, that **WALL MOUNTED MODELS 2300-9124; 2400-9124; 2500-9124; 2500-1416** fulfills the Competition Level II and **WALL MOUNTED MODEL S 2300; 2400 AND 2500** fulfills the Competition Level III standards specified in the latest edition of the Equipment & Venue Approval Programme and GARED is therefore qualified as an Official Technical Partner. (Contract Number: P04-2015)

LENGTH	35' X 20" BACKBOARD MOUNTING COMPATIBILITY		63' X 36" BACKBOARD MOUNTING COMPATIBILITY	
	WALL MOUNT	ADJUST-A-GOAL	WALL MOUNT	ADJUST-A-GOAL
THREE-POINT STATIONARY WALL MOUNT SERIES				
2' to 3'	2350-2034	2350-2034A	2350-2030	2350-2030A
3' to 4'	2350-3044	2350-3044A	2350-3040	2350-3040A
4' to 6'	2350-4064	2350-4064A	2350-4060	2350-4060A
6' to 9'	2350-6094	2350-6094A	2350-6090	2350-6090A
9' to 12'	2350-9124	2350-9124A	2350-9120	2350-9120A
FOUR-POINT STATIONARY WALL MOUNT SERIES				
2' to 3'	2300-2034	2300-2034A	2300-2030	2300-2030A
3' to 4'	2300-3044	2300-3044A	2300-3040	2300-3040A
4' to 6'	2300-4064	2300-4064A	2300-4060	2300-4060A
6' to 9'	2300-6094	2300-6094A	2300-6090	2300-6090A
9' to 12'	2300-9124	2300-9124A	2300-9120	2300-9120A
FOUR-POINT SIDE-FOLD WALL MOUNT SERIES				
2' to 3'	2500-2034	2500-2034A	2500-2030	2500-2030A
3' to 4'	2500-3044	2500-3044A	2500-3040	2500-3040A
4' to 6'	2500-4064	2500-4064A	2500-4060	2500-4060A
6' to 9'	2500-6094	2500-6094A	2500-6090	2500-6090A
9' to 12'	2500-9124	2500-9124A	2500-9120	2500-9120A
FOUR-POINT FOLD-UP WALL MOUNT SERIES				
2' to 3'	2400-2034	2400-2034A	2400-2030	2400-2030A
3' to 4'	2400-3044	2400-3044A	2400-3040	2400-3040A
4' to 6'	2400-4064	2400-4064A	2400-4060	2400-4060A
6' to 9'	2400-6094	2400-6094A	2400-6090	2400-6090A
9' to 12'	2400-9124	2400-9124A	2400-9120	2400-9120A

WALL MOUNT PACKAGES

LENGTH	WALL MOUNT MAIN COURT GYM PACKAGE	WALL MOUNT SIDE COURT GYM PACKAGE
THREE-POINT STATIONARY WALL MOUNT SERIES		
2' to 3'	P2350-2034GL	P2350-2030ST
3' to 4'	P2350-3044GL	P2350-3040ST
4' to 6'	P2350-4064GL	P2350-4060ST
6' to 9'	P2350-6094GL	P2350-6090ST
9' to 12'	P2350-9124GL	P2350-9120ST
FOUR-POINT STATIONARY WALL MOUNT SERIES		
2' to 3'	P2300-2034GL	P2300-2030ST
3' to 4'	P2300-3044GL	P2300-3040ST
4' to 6'	P2300-4064GL	P2300-4060ST
6' to 9'	P2300-6094GL	P2300-6090ST
9' to 12'	P2300-9124GL	P2300-9120ST
FOUR-POINT SIDE-FOLD WALL MOUNT SERIES		
2' to 3'	P2500-2034GL	P2500-2030ST
3' to 4'	P2500-3044GL	P2500-3040ST
4' to 6'	P2500-4064GL	P2500-4060ST
6' to 9'	P2500-6094GL	P2500-6090ST
9' to 12'	P2500-9124GL	P2500-9120ST
FOUR-POINT FOLD-UP WALL MOUNT SERIES		
2' to 3'	P2400-2034GL	P2400-2030ST
3' to 4'	P2400-3044GL	P2400-3040ST
4' to 6'	P2400-4064GL	P2400-4060ST
6' to 9'	P2400-6094GL	P2400-6090ST
9' to 12'	P2400-9124GL	P2400-9120ST

GARED STANDARD WALL MOUNT products in chart above do not include backboards, rims or padding • If needing, the entire set-up, our **WALL MOUNT PACKAGES** feature our most popular configurations and include all components.

WALL MOUNT MAIN COURT PACKAGE INCLUDES:
 AFRG42 42" X 72" Rectangular Glass Backboard, 2000+ Breakaway Rim, PMCE Bolt On Padding

WALL MOUNT SIDE COURT PACKAGE INCLUDES:
 I245T Fan-Shape Steel Backboard With Orange Target, 1000 Breakaway Rim



HEIGHT ADJUSTERS

Bring all ages into the game and make your facility user friendly to even the youngest players, giving them the ability to compete at heights that are fair and fun for them • Our height adjusters lower your backboards to any height between 8' and 10' • The goal height indicator is located on the unit for accurate adjustment • All of our height adjusters feature direct goal attachment to transfer any stress and load from the goal to the backstop's structure instead of depending on the backboard for support • Please note, adding GARED's height adjuster to an existing basketball structure may affect the court dimensions.

1130: MANUAL SINGLE POST HEIGHT ADJUSTER SERIES

2 YEAR LIMITED WARRANTY, WEIGHT: 73 LBS, TRUCK, FREIGHT CLASS 70, 24 HOUR SHIP

1170: ELECTRIC SINGLE POST HEIGHT ADJUSTER SERIES

• 1158 Hardwire kit is required for operation, not included in 1170
2 YEAR LIMITED WARRANTY, WEIGHT: 84 LBS, TRUCK, FREIGHT CLASS 70, 24 HOUR SHIP

1140: MANUAL DUAL POST HEIGHT ADJUSTER SERIES

2 YEAR LIMITED WARRANTY, WEIGHT: 73 LBS, TRUCK, FREIGHT CLASS 70, 24 HOUR SHIP

1180: ELECTRIC DUAL POST HEIGHT ADJUSTER SERIES

2 YEAR LIMITED WARRANTY, WEIGHT: 84 LBS, TRUCK, FREIGHT CLASS 70, 24 HOUR SHIP

1179: MANUAL TO ELECTRIC HEIGHT ADJUSTER CONVERSION KIT

Manual height adjusters can be converted to electric by adding a motor kit • This can be done on location.

UNIQUE FEATURE

Spring activated manual locking mechanism is designed to lock the rod in place eliminating any "drifting" of the backboard height on all manual height adjusters • (Patent 8043174)



MANUAL AAG	ELECTRIC AAG	TYPE OF ATTACHMENT
1131	1171	Basic adjust-a-goal (no mounting brackets)
SINGLE POST BACKSTOPS		
1132	1172	Single post adjust-a-goal for 6 5/8" diameter single post for rectangular backboard with 63" x 36" board mounting; includes basic adjust-a-goal and kits 1408 & 4404
1133	1173	Single post adjust-a-goal for 6 5/8" diameter single post for fan-shape backboard with 35" x 20" board mounting; includes basic adjust-a-goal and kits 1408 & 4405
1134	1174	Single post adjust-a-goal for rectangular backboard with 63" x 36" board mounting, single post other than 6 5/8"; includes basic adjust-a-goal and kit 4404. Does not include aag to post mtg • parts • (for custom size posts)
1135	1175	Single post adjust-a-goal for fan-shape backboard with 35" x 20" board mounting, single post other than 6 5/8"; includes basic adjust-a-goal and kit 4405. Does not include aag to post mtg • parts • (for custom size posts)
DUAL POST BACKSTOPS		
1142	1182	Adjust-a-goal for 3 1/2" diameter dual post for rectangular backboard with 63" x 36" board mounting; includes basic adjust-a-goal and kits 3513 & 4404
1143	1183	Adjust-a-goal for 3 1/2" diameter dual post for rectangular backboard with 35" x 20" board mounting; includes basic adjust-a-goal and kits 3513 & 4405
1144	1184	Adjust-a-goal for 2 3/8" diameter dual post for rectangular backboard with 63" x 36" board mounting; includes basic adjust-a-goal and kits 2108 & 4404
1145	1185	Adjust-a-goal for 2 3/8" diameter dual post for rectangular backboard with 35" x 20" board mounting; includes basic adjust-a-goal and kits 2108 & 4405
WALL MOUNTED BACKSTOPS		
1146	1186	Adjust-a-goal for GARED wall mounts for rectangular backboard with 63" x 36" board mounting; includes basic adjust-a-goal and kits 5741 & 4404
1147	1187	Adjust-a-goal for GARED wall mounts for rectangular backboard with 35" x 20" board mounting; includes basic adjust-a-goal and kits 5742 & 4405
NON-STANDARD AND NON-SINGLE POST BACKSTOPS		
1148	1188	Adjust-a-goal for rectangular backboard with 63" x 36" board mounting; non-standard non-single post; includes basic adjust-a-goal and kits 4404
1149	1189	Adjust-a-goal for fan-shape backboard with 35" x 20" board mounting; non-standard non-single post; includes basic adjust-a-goal and kits 4405

THE ELECTRIC HOIST is the most convenient way to raise and lower your gymnasium equipment • Direct drive with no dangerous belts or pulleys • Utilized for ceiling and swing up wall mounted basketball backstops • High-strength metal gears • Hardened steel worm gear is captured to take on radial and thrust loads • Our winch is specified to continuously run at the maximum rated load of 1250 lbs/ 566 kilograms for the motors rated duty cycle of 20 minutes without sustaining any gear damage. Our tests show that metal gears consistently outperform other materials under strenuous conditions, especially plastic • Limit switch makes setting the limits a breeze for installers • Once set properly, the limit switch will not lose its critical settings due to vibration or environmental conditions • Powerful, instantly reversing ¾ HP motor (UL listed) is governed to stall at 14 amps • Large grooved drum ensures long cable life and proper coiling • Basic cable care ensures a long, safe life • That's why we machine precise grooves in our drum and include a tension roller to guarantee correct cable tracking, even in slack conditions • Positive locking in the double reduction worm gear drive that provides for a strong hold under load • Sealed gear case with precision ball bearings and a premium seal for a lifetime of maintenance-free operation • Supplied with single key switch and stainless steel cover • Electrical contractor shall supply all conduit, wiring, junction boxes and other components not listed above • UL Listed.



1194: ELECTRIC HOIST WITH KEY SWITCH

5 YEAR LIMITED WARRANTY, WEIGHT: 73 LBS, TRUCK, FREIGHT CLASS 70, 24 HOUR SHIP

1197: ELECTRIC HOIST WITH WIRELESS REMOTE RECEIVER

5 YEAR LIMITED WARRANTY, WEIGHT: 77 LBS, TRUCK, FREIGHT CLASS 70, 24 HOUR SHIP



1123

THE MANUAL WINCH is engineered and built for high strength and durability for those facilities on a budget • Heavy-duty capacity for 1,000 lb loads • Grooved drum for accurate winding, with a constant pressure roller preventing the cable from climbing the drum ends • Efficient 40:1 worm gear ratio • Precision thrust bearings provide smooth operation under load • Maintenance-free gear case offers a lifetime of lifting without hassle • Optimized cable routing close to the wall to reduce stress to the winch mounts during use to ensure a long and safe cable life • Supplied with wood buck for mounting to wall and removable handle for operation.

- Precision interlocking steel frame for rigidity and precise alignment
- Semi-enclosed, self lubricating worm gear with load rating of 1000 lbs.
- Grooved drum, for accurate winding, with a constant pressure roller preventing the cable from climbing the drum ends
- Braking is provided by double self-locking worm gearing with a passive uni-directional brake
- Winch is supplied with a cover and mounted directly to the wall
- Winch is supplied with a removable handle with a free turning sleeve that provides an easy, no friction grip.

1123: MANUAL WINCH

5 YEAR LIMITED WARRANTY, WEIGHT: 36 LBS, TRUCK, FREIGHT CLASS 70, 24 HOUR SHIP

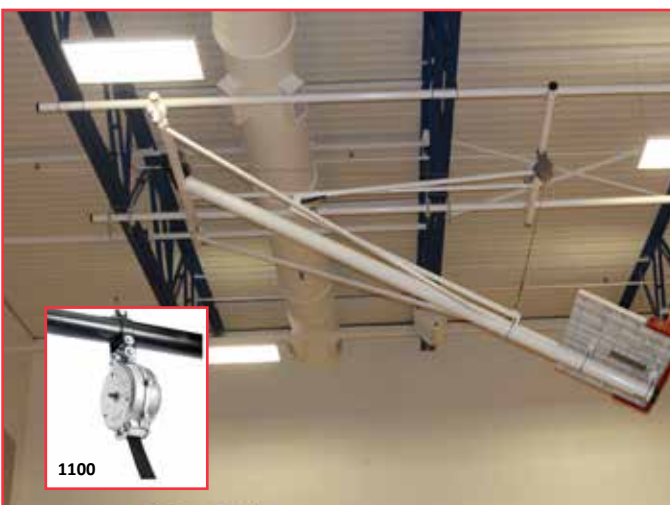

1100

The **SAFSTOP SAFETY LOCKING STRAP** is the industry standard for overhead gymnasium safety • Protect your facility with a tested product designed to catch a backstop in the slight chance of winch or cable failure • The Safstop Safety Strap is uniquely manufactured using a multi-pawl design with inertia plate to promote safety in your gymnasium • Attaches to a fixed position on your ceiling or wall mounted backstops to prevent the apparatus from falling if the unit should fail • Universal mounting clamp allows for installation parallel or 90 degrees to the backboard • Positive locking steel pawls simultaneously engage the teeth in the all-steel plate housing

1100: SAFSTOP SAFETY LOCKING STRAP

5 YEAR LIMITED WARRANTY, WEIGHT: 20 LBS, TRUCK, FREIGHT CLASS 70, 24 HOUR SHIP

The **PORTABLE ELECTRIC WINCH WINDER** is the most economic means to power all up fold backstops with manual winches installed • Buy only one portable winch winder and use it for any number of backstops • Features reversing switch enabling the backstop to be raised or lowered without disengaging winder • Geometric right angle drive allows for easy handling • Winch winder has heavy-duty single-phase 115-volt motor.

1119: PORTABLE ELECTRIC WINCH WINDER

1 YEAR LIMITED WARRANTY, WEIGHT: 26 LBS, TRUCK, FREIGHT CLASS 70, 24 HOUR SHIP



1119

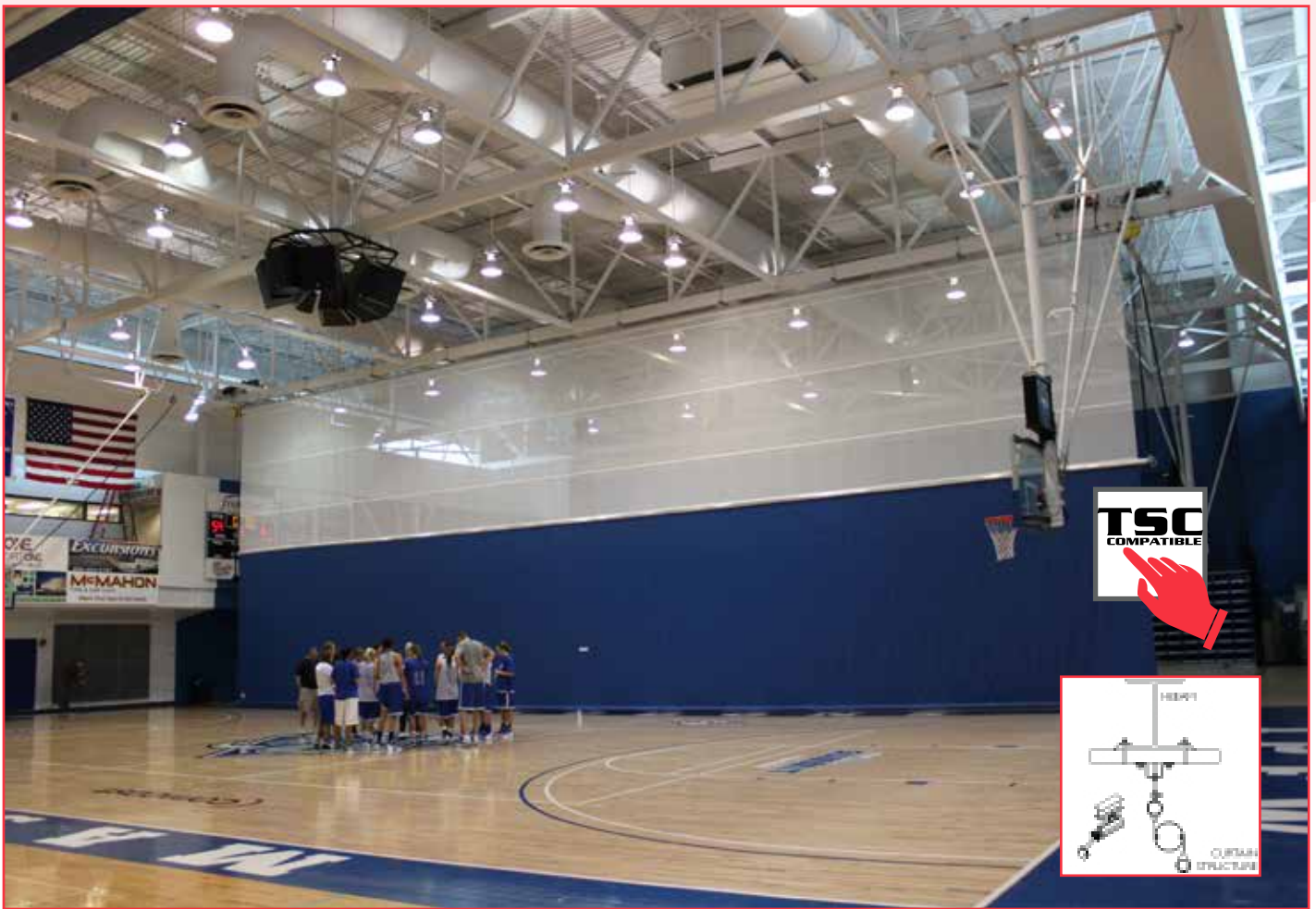

When it comes to maximizing your gym space no one does it better than **GARED**. Our engineers have kept with our history of innovation and expanding customer choice with the **4050 CENTER-DRIVE CURTAIN SYSTEM**. The **CENTER DRIVE** offers the same great features of our Top Roll Curtain such as maximum clearance when in the stored position, operation without belts, cables, or exposed wires, but goes a step further by eliminating the need for large rollers which require extensive overhead structure attachment. Our Center Drive is a unique design that uses internal tubular motors and a counterweight that eliminates the need for costly extension arms with straps connected at the upper structure to resist the torque of the motor. **GARED'S CENTER DRIVE** also utilizes a larger drive tube raising and lowering the curtain 25% faster than the competition. Whether it's speed, clearance, or aesthetics you're looking for, the **CENTER DRIVE** has it all!

FEATURES:

MATERIAL: Lower half can be either 19 or 22 oz. polyester reinforced, fire retardant and mildew resistant vinyl fabric • Seams are electronically welded with a full contact weld • A padded pocket is formed in bottom edge of curtain to accommodate a 1.9" O.D. bottom batten while a similar pocket of vinyl or mesh houses the top batten of the same size • Upper half of curtain is comprised of 9 oz. vinyl coated polyester mesh.

DRIVE STRUCTURE: Depending on the curtain size, it is operated by one or two internal tubular motors (120 volt, 60 hertz, single phase) • Each motor has a max torque of 700 inch pounds with a speed of 14 rpm • Each motor is equipped with integral up and down limit switches with locking push buttons and electromagnetic disk brakes for smooth and accurate stop without slippage and allows full braking power in the event of power failure • The 4" O.D. drive tube is affixed in center of curtain allowing for increased speed of operation.

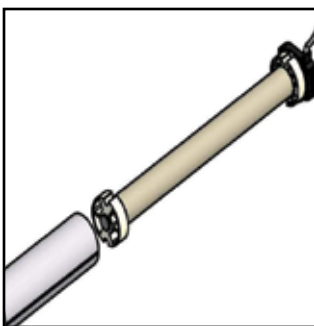

INTERNAL MOTOR SYSTEM

- Clean look with no wires or cables exposed
- Internal driveshaft motors enable lower power requirement and lower torque to move with similar speed as standard external motors
- Standard motors pull 15 amps, ours only 3.5 amps
- Internal motors allow for larger variation of building configurations with space constraints
- Used on Models 4050, 4040XL

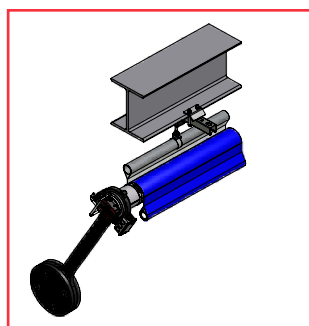

TORQUE COUNTER WEIGHT

GARED's torque counter-weight feature is new technology which does not require any connection to the structure to resist the torque of the motors providing a much cleaner and less complicated installation than the competition. Once positioned in the drive tube and attached to the motor, no belts, structure attachments or further adjustments are required.



The **4020 FOLD-UP GYM CURTAIN** is the most cost effective solution on the market • The fold up divider curtain offers a great solution for dividing your space for better utilization by providing years of worry free service.

FEATURES:

- Easy installation
- IHP electric operation – key switch, key pad, wireless remote
- Independent cast aluminum drums - easily adjustable
- 19 oz or 22 oz vinyl lower section and 9oz upper section
- Vinyl coated mesh upper section with welded seams and fully padded batten – no exposed hardware
- 2 3/8" diameter centerline continuous drive shaft for even curtain balance and load distribution
- Straight or curve design available
- Optional curtain lock safety device locks drive shaft if speed exceeds 1-1/2" per second.



TSC COMPATIBLE

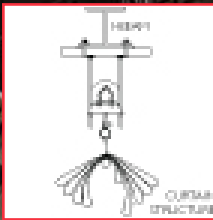

4020-R RADIUS CURTAIN

The **4040XL TOP ROLL GYM DIVIDER CURTAIN** provides a solution for those facilities with height clearance issues • This low profile divider curtain is designed to operate without belts, cables, exposed wires or guide systems • Fabric rolls within 13.5" of ceiling overhead for maximum clearance • Innovative and extremely quiet internal tubular motor with all electrical components neatly packaged inside the drive tube • Newly designed expandable roller system • Larger drive tube with vented ends for cooling of the motors • 19 oz. or 22 oz. vinyl lower section and 9 oz. vinyl coated mesh upper section • Curtain has welded seams, fully padded bottom batten, and no exposed hardware • Mounting assemblies allow for easy installation and leveling.

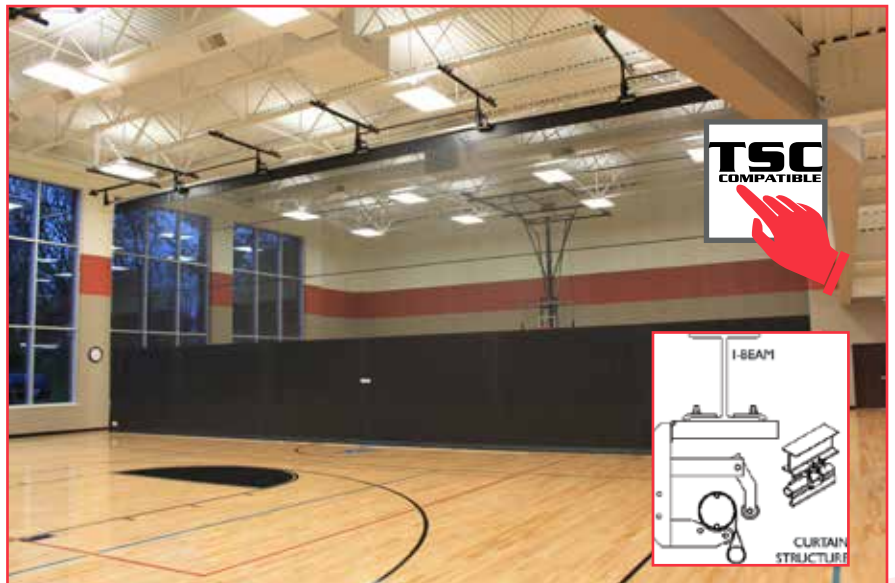

TSC COMPATIBLE

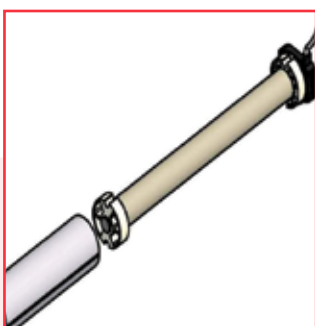
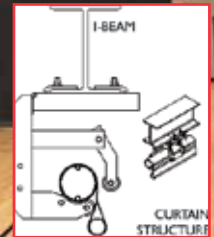

INTERNAL MOTOR SYSTEM

- Clean look with no wires or cables exposed
- Internal driveshaft motors enable lower power requirement and lower torque to move with similar speed as standard external motors
- Standard motors pull 15 amps, ours only 3.5 amps
- Internal motors allow for larger variation of building configurations with space constraints
- Used on Models 4050, 4040XL

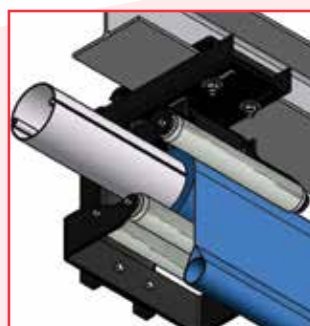

DESIGNED CARRIER SYSTEM

- Increased diameter aluminum drive pipe for speeding up the roll time and prolonging the vinyl life
- New ball bearing roller assembly designed with longer rollers to distribute the vinyl load, reducing stress on the material
- Hardened steel rollers eliminate dirt buildup and tracking marks on vinyl that wood or rubber rollers create
- 13.5" compact profile for height clearance issues

4030 ROLL-UP CURTAIN

The roll-up divider curtain features the automatic operation of a fold-up curtain without the cables.

FEATURES:

- Curtain rolls on the 3 1/2" diameter bottom batten for a smooth wrinkle free surface when rolled and stored
- Curtain is driven with 4" wide black polyester webbing
- Compact 24" clearance in stored position
- Optional curtain lock safety device locks drive shaft if speed exceeds 1-1/2" per second.

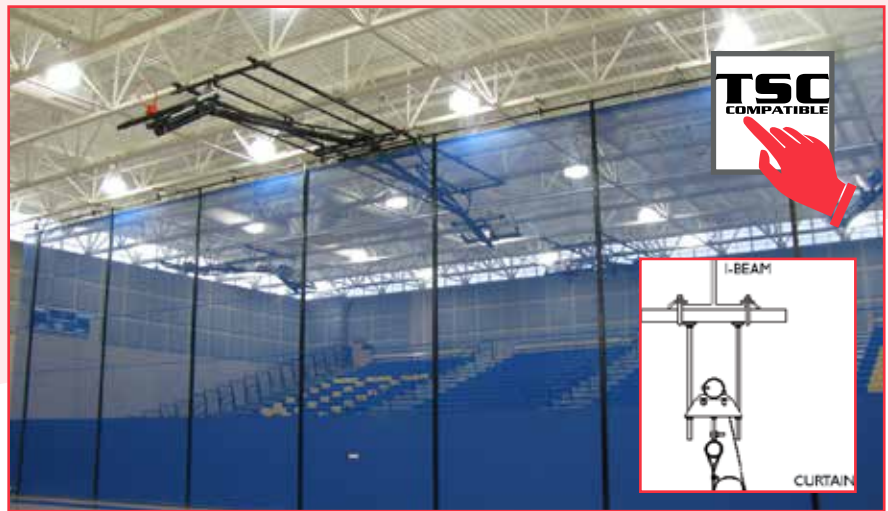
**4025 PEAK-FOLD CURTAIN**

Precision designed to fold to exact ceiling contour of most buildings • When sloped ceilings require creative use of space, the peak-fold curtain is the best solution.

FEATURES:

- Equipped with 1/8" cables, spaced not more than 10' apart, ending in individual hoist drums
- Custom engineered variable diameter cable drums match individual cable travel to the ceiling slope
- Hoist driven by IHP, 115 VAC gear motor with overload thermal protection, single-keyed toggle key switch
- No exposed hardware

**4013 WALK-DRAW CURTAIN**

Economically functional • This convenient track-style curtain offers an economical answer to your space dividing needs.

FEATURES:

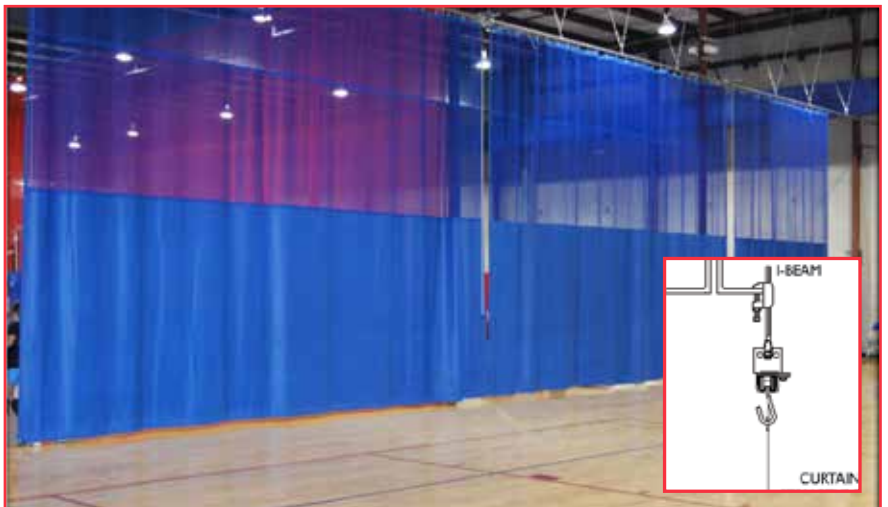

- Easy installation
- Manual operation with 1-7/16" wide enclosed galvanized steel track
- Carriers spaced no more than 12" apart with 1" diameter polyurethane wheels
- Can be stored flat against a wall or in small corners of a facility



Customize your divider with school pride by adding a GARED's customized **GRAPHIC** option.

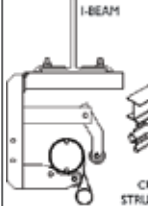
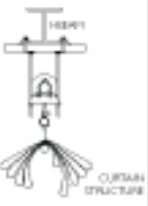
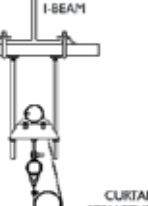

GRAPHIC: ADD GRAPHICS TO DIVIDER CURTAIN ORDER

PLAYRX™ GYMNASIUM DIVIDER CURTAIN PRODUCT GUIDE



MODEL NUMBER	MODEL 4050	MODEL 4040 XL	MODEL 4020	MODEL 4030	MODEL 4025	MODEL 4013
STRUCTURE						
DESIGN APPLICATION	Great for all facilities and especially for those with limited clearance height over volleyball courts.	Great for all facilities and especially for those with limited clearance height.	Great for all facilities, especially for those not concerned with clearance height issues.	Great for all facilities, especially for those with limited clearance height.	Great for facilities with pitched or sloped roof structure.	Great for facilities with wall space for stacking curtain when opened.
RECOMMENDED HEIGHT:	20' to 40'	15' to 36'	15' to 60'	15' to 30'	3:12 pitch or under	10' to 30'
RECOMMENDED WIDTH:	20' to 120'	20' to 130'	20' to 130'	20' to 120'	40' to 120'	10' to 80'
PLEASE NOTE: MAXIMUM CURTAIN WIDTH AND HEIGHT ARE DETERMINED BY THE WEIGHT OF THE STRUCTURE. ALL CURTAIN DIMENSIONS SHOULD BE SENT TO GARED FOR APPROVAL PRIOR TO SPECIFICATION CONSTRUCTION.						
STORAGE DIMENSION:	14"	13.5"	48" (varies)	36"	48" (varies)	10% of (Curtain width + 10%)
AVERAGE RUN SPEED:	36 ft per min	18.4 ft per min	6.9 ft per min	8.3 ft per min	18.1 ft per min	N/A
STORAGE TYPE	Roll Up	Roll Up	Curtain Stack	Roll Up	Curtain Stack	Wall Stack
DESIGN FEATURE	No Cables, Belts, Or Rollers, Speed	No Cables Or Belts	Cable Pull	Belt Pull	Stacks Level with Roof	
COST	\$\$\$\$	\$\$\$	\$\$	\$\$	\$\$\$\$	\$

STANDARD CURTAIN VINYL COLORS





19 OZ. VINYL COLORS

									
MARINE	ROYAL	YELLOW	KELLY	ORANGE	NAVY	FOREST	PURPLE	RED	BURGUNDY
									
WHITE	BEIGE	BLACK	GREY						

22 OZ. VINYL COLORS

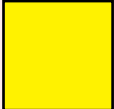
		
ROYAL	RED	GREY

9 OZ. MESH COLORS

						
WHITE	YELLOW	GREEN	RED	BLUE	BLACK	GREY



4090 MAT STORAGE SYSTEM

MAT CARRIER SYSTEMS AND INDOOR SPORTING CAGES

The traveling **MODEL 4095 MAT CARRIER SYSTEM** offers all of the same features as our standard system, but with the advantage of mobility • Allows mats to be raised and transported for ceiling level storage or transported to and from balcony or second level storage areas • Optional sling configurations same as stationary model, plus the ability to transport three 14' x 42' mat sections in an oversize single sling • The stationary **MODEL 4090/4091 MAT STORAGE SYSTEM** easily stores 1 or 2 mats at ceiling level • Optional sling configurations will store one 42' to 45' mat in a single sling, two 42' mats in one large single sling or two 42' mats in two individual slings, stacked either vertically or horizontally • Operated by 2 horsepower, 208/220 volt, 60 cycle, single or three phase or 460/480V/60 HZ. 3-phase instant reverse motors • Features 50-1 industrial C-face inline helical gear speed reducer and a 20 ft./lbs electric brake • Please specify voltage, phase, and sling type.

MAT HOIST MODEL	TYPE OF LOAD BAR	OPTION	MOVEMENT DIRECTION
4090-A	40' Single Load Bar	A	Stationary Mat Hoist
4090WM-A	40' Single Load Bar	A	Stationary Mat Hoist
4090-DS-B	40' Double Load Bar	B	Stationary Mat Hoist
4090WM-DS-B	40' Double Load Bar	B	Stationary Mat Hoist
4090-DS-C	40' Double Load Bar	C	Stationary Mat Hoist
4090-DS-D	40' Double Load Bar	D	Stationary Mat Hoist
4091-DS-E	20' Double Load Bar	E	Stationary Mat Hoist
4096-A	40' Single Load Bar	A	Forward Moving Mat Hoist
4096-DS-B	40' Double Load Bar	B	Forward Moving Mat Hoist
4096-DS-C	40' Double Load Bar	C	Forward Moving Mat Hoist
4096-DS-D	40' Double Load Bar	D	Forward Moving Mat Hoist
4095-DS-E	20' Double Load Bar	E	Forward Moving Mat Hoist
4097-DS-E	14' Double Load Bar	E	Mini Stationary Mat Hoist
4098-A	40' Single Load Bar	A	Side Moving Mat Hoist
4098-DS-B	40' Double Load Bar	B	Side Moving Mat Hoist
4098-DS-C	40' Double Load Bar	C	Side Moving Mat Hoist
4098-DS-D	40' Double Load Bar	D	Side Moving Mat Hoist



4095 MAT STORAGE SYSTEM

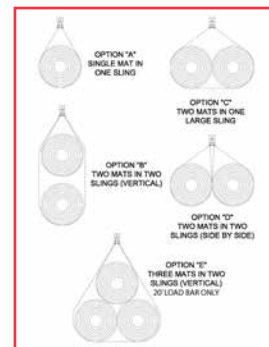

MODEL 1109 MAT STORAGE LOCK Safety system to prevent free-fall of mat slings due to cable or hoist gearbox failure • Any sudden surge of speed shall instantly lock and hold the sling in any position.

MODEL 4080 MULTI SPORT CAGE and **MODEL 4081 BATTING CAGE** are electrically operated practice cages that conveniently suspend from the ceiling structure • Offered in standard sizes listed below, custom sizes are available to fit your facility needs • Drive shaft raises and lowers system powered by our curtain hoist • Square mesh with Velcro® corners on sidewall to be raised for entry and exit on all multi-sport nets • Standard net color is black • Radius pipe on top of the net is custom.

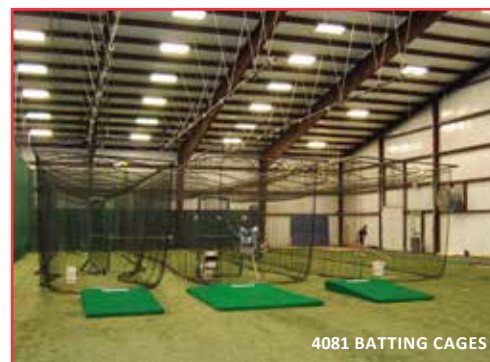

4081 BATTING CAGES

CAGE MODEL	TYPE OF CAGE	SIZE	NET MODEL	NET SIZE	MESH SIZE	MESH COLOR
4080-70	Multi-Sport	10'H x 12'W x 70'L	4087	12'H x 12'W x 70'L	3/4" Square	Black
4081-70	Batting Cage	10'H x 12'W x 70'L	4089	12'H x 12'W x 70'L	1 3/4" Square	Black
4080-55	Multi-Sport	10'H x 12'W x 55'L	4086	12'H x 12'W x 55'L	3/4" Square	Black
4081-55	Batting Cage	10'H x 12'W x 55'L	4088	12'H x 12'W x 55'L	1 3/4" Square	Black



4080 MULTI-SPORT CAGE



MODEL 4080BL BOTTOM LIFT MULTI SPORT CAGE and **4081BL BOTTOM LIFT BATTING CAGE** are electrically operated sports cages that suspend from the ceiling • The bottom of the cage netting is automatically lifted to the top frame eliminating the need to manually drape the net over the frame before lifting • Nylon straps hold the top frame at a preset height above the floor during use • Double cable spools uniformly pull up each side of the lower cage batten frame to within 1'- 9" of the structure.

CAGE MODEL	TYPE OF CAGE	SIZE	NET MODEL	NET SIZE	MESH SIZE	MESH COLOR
4080BL-70	Multi-Sport	10'H x 12'W x 70'L	4087	12'H x 12'W x 70'L	3/4" Square	Black
4081BL-70	Batting Cage	10'H x 12'W x 70'L	4089	12'H x 12'W x 70'L	1 3/4" Square	Black
4080BL-55	Multi-Sport	10'H x 12'W x 55'L	4086	12'H x 12'W x 55'L	3/4" Square	Black
4081BL-55	Batting Cage	10'H x 12'W x 55'L	4088	12'H x 12'W x 55'L	1 3/4" Square	Black



Our **MODEL 4075 INDOOR CEILING SUSPENDED THROWING CAGE** is a top quality unit for use in facilities where frequent indoor track and field set-up is required • This product meets all USTF and NCAA requirements for indoor throwing cages • The net is constructed of 600lb test (minimum), #72 knotted nylon.

The **HAMMER THROW DOOR FRAME SYSTEM** is comprised of two vertical frame members hinged at the truss connection point to allow the frames and wing doors to fold as a single unit • Frames are 4" square heavy wall tubing, extended to the floor in the down position to support doors in the proper position for the event • Frames are folded into the stored position by means of 1/4" galvanized aircraft cable on each vertical frame using a 3/4 HP double drum electric hoist • The net is constructed of 600lb test (minimum), #72 knotted nylon.

The **REAR CAGE FRAME** is constructed of 1.9" O.D. heavy wall tubing featuring a cross spreader spans the perimeter of the cage to maintain a 5' distance required by the NCAA rule • The frame is raised to the overhead storage position by means of six 1/8" galvanized aircraft cables routed through swivel pulleys to a central drive pipe • The drive system is powered by a 3/4 HP electric motor • The net is constructed of 600lb test (minimum), #72 knotted nylon.



GYMNASIUM ACCESSORIES

Our **WALL PADDING** protects players from contact in your play environments • A must behind basketball backstops and in wrestling rooms or workout areas, we offer a vast selection of padding choices, from walls to stages to custom structures, no matter your need GARED has you covered! • Our specifications meet and/or exceed the industry safety standards • All GARED wall padding is covered in 14 oz. polyester laminated vinyl that is rot, mildew, & fungus resistant as well as passes the rigorous ASTM E 84 flame resistance testing method required by today's stringent fire safety codes around the world • This vinyl is fully wrapped over your choice of foam, and adhered to a 7/16" OSB board to provide a time tested combination to keep your play area an impact safe zone. We offer various foam types to meet the requirement of your specific safety needs.



I-BEAM PAD



Show your school pride with **GARED'S GRAPHIC PADDING**. Available in just about any design you can dream up, GARED Graphic pads are a great way to give your gym padding a personalized touch.

WALL PADDING FOAM TYPES



STANDARD FOAM: POLYURETHANE FOAM is recommended for areas with less aggressive play or with safer distances to any possible impact risk • Constructed of all virgin material, polyurethane was one of the first foam selections offered for wall padding • With a density measuring 3 1/2 lbs., polyurethane is better suited for the light impact areas.



IMPACT FOAM: BONDED OR POLYETHYLENE FOAM is recommended for areas with high aggressive play and close to possible impact risk • Impact foams are comprised of two types of foam: **2" BONDED POLYURETHANE FOAM** or our **2 1/4" POLYETHYLENE FOAM** • Both foams are tested per ASTM F1292-09 testing methods and meet all the requirements of the ASTM F2440-11, which is the industry standard for impact.



FIRE RATED FOAM: NEOPRENE FOAM is a 5.0lb density foam produced utilizing low smoke polychloroprene latex compound making it the only choice when your entire pad assembly (foam, board, and vinyl) are required to meet the strenuous ASTM E84 Class "A" Fire code test • This foam selection creates a combination that meets even the most stringent of local fire codes!



XX-FIRM NEOPRENE FOAM is ideal for high impact and stringent fire code safety environments • Our XX-Firm 2" Neoprene Foam passed the ASTM E84 fire rating standards as well as the ASTM F1292-0.

WALL PADDING ATTACHMENT METHODS

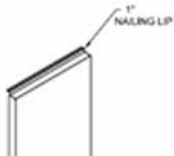

NAIL LIP STANDARD ATTACHMENT is the perfect choice for permanently mounted padding • 1" nail lip at the top and the bottom of the pad provided for placement of building approved fasteners.



"J" CHANNEL MOUNTING SYSTEM is ideal for those environments that require removal of padding on a very infrequent basis • Our "J" Channel system also provides the pads with a clean, finished look by utilizing an extruded aluminum channel at top and bottom of pad for attachment that is visible from the outside • Channels should be mounted to sound structure with attachment methods approved for building conditions

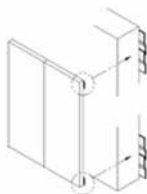

"Z" CLIP MOUNTING SYSTEM is the solution for a secure but removable attachment method • Our "Z" Clip is mounted in two locations both to the wall and on the padding providing ease of removal and an attachment method that conceals all fasteners from site.

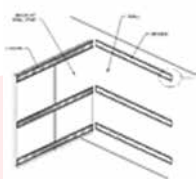

ALUMINIUM CHANNEL WITH HOOK & LOOP FASTENER is the attachment choice for easily removable padding • This attachment method is concealed and allows for frequent removal of padding • System comes complete with three aluminum extruded channels and Velcro® hook for attachment to wall and either sewn or glued (for retrofit) Velcro loop on padding which creates a clean and secure attachment.

All **GARED® PADDING CHOICES** are available in custom configurations for corners, columns, I beams, and even stages to meet all of your padding needs • Other options such as Vonar® interliner and or fire rated backer board available as well.

TOTAL SYSTEM CONTROLS

TAKE BACK CONTROL OF YOUR GYMNASIUM EQUIPMENT WITH OUR TOTAL SYSTEM CONTROLS SYSTEMS (TSC). OUR TSC OPTIONS GIVE FACILITY MANAGERS EQUIPMENT MOVEMENT CONVENIENCE WITH FINGER TIP CONTROL!



The **MODEL TSC1500 ELECTRONIC CONTROL SYSTEM** and **KEYPAD** is an economical option for the operation of basketball backstops, divider curtains, lighting, scoreboards, public address systems or just about any other electrically operated equipment through a wall-mounted keypad • Unlike the more advanced TSC models, the TSC1500 does not require factory preset programming; all functions can be conveniently programmed in the field • This system is a great low cost alternative for new or retrofit gymnasium installations.

MAIN FEATURES:

- Singular device operation
- Multiple device operation in groups of up to eight devices
- Can control a maximum of one hundred and sixty devices
- Can handle a total of seventy five possible moving groups
- Can operate fifty auxiliary devices
- Power panel back up operating system
- Less electrical wiring required
- Passcode protected
- No keys required



MODEL TSC2000 & TSC2000X TOTAL SYSTEM CONTROL

allows one touch operation of basketball backstops, divider curtains, lighting, scoreboards, public address systems or just about any other electrically controlled equipment through a wall-mounted keypad • One keypad and relay box will operate eight motorized systems and auxiliary operations (lighting, scoreboards, etc.) • System uses twenty multi-function keys with illuminated 20-character LCD display for easy readout • Operates on 110 volts with keypad communications at 24 volts DC and mounts in a standard 12" x 12" x 6" inch deep enclosure • Relay panel (24" x 24" x 6") can be mounted in any remote location • System will operate equipment individually and has custom program options for multiple equipment configurations such as "game day" or "practice" set-up • **TSC2000X SYSTEM** has expandability to operate additional equipment by adding relay cards • System can control devices in pairs • Password controlled to prevent unauthorized use • "Press and hold" button feature prevents authorized operator from walking away while equipment is in motion • Auto shut-off after thirty seconds of non-use • Unit is self-diagnostic and has voltage-sensing shutdown feature in case of overload, and will recommend electrical maintenance if needed.



MODEL TSC2000XL ADVANCED ELECTRONIC CONTROL SYSTEM

and **TOUCH SCREEN** allows one touch operation of basketball backstops, divider curtains, lighting, scoreboards, public address systems or just about any other electrically controlled equipment through a wall-mounted touch screen • One touch screen and relay box will operate eight motorized systems and auxiliary operations (lighting, scoreboards, etc.) • System uses 7.5" touch screen • Operates on 110 volts with screen

communications at 24 volts DC and mounts in a standard 12" x 12" x 6" deep enclosure • Relay panel (24" x 24" x 6") can be mounted in any remote location • System will operate equipment individually and has custom program options for multiple equipment configurations such as "game day" or "practice" set-up • System has expandability for operating additional equipment by adding relay cards • System can operate up to 6 devices simultaneously • Password controlled to prevent unauthorized use • Press and hold" button feature prevents authorized operator from walking away while equipment is in motion • Auto shut-off after thirty seconds of non-use • Unit is self-diagnostic and has voltage-sensing shutdown feature in case of overload, and will recommend electrical maintenance if needed • All other electrical, junction and synchronizer boxes not mentioned above must be furnished and installed by a certified electrical contractor.

TSC MODEL	1500	2000	2000X	2000XL
Key Pad	X	X	X	
Touch Screen				X
Multiple Level Password Control Protection	X	X	X	X
Operate Individually	X	X	X	X
Operate in Pairs or in Groups	X	X	X	X
Low Voltage Wiring from Relay Panel to Key Pad	X	X	X	X
Self Diagnostic with Screen Readout		X	X	X
Soft Interlocks permit Sequential Operation		X	X	X
Operate Auxiliary Devices, Lighting, Scoreboards, Bleachers, etc.	X	X	X	X
Interactive Diagnostics w/Instant Feedback & Repair Information		X	X	X
In Field Upgrade Capability (Compact Flash Card)		X	X	X
Full Color Interactive LCD Touch Display				X
Control Box Secondary Operation Available	X	X	X	X
Protective Cover Available	X	X	X	X
On Screen Instructions		X	X	X
Event Log		X	X	X



Our **CLIMBING ROPES** are available in three different materials with a variety of options for ends, knots, accessories and attachment methods • Standard lengths are 18' with custom lengths also available.

CLIMBING ROPE MODEL	ROPE MATERIAL	ROPE ENDING
I03MB	Manila Rope	Braided Rope End.
I03MPB	Manila Rope	Poly Boot End
I03MTK	Manila Rope	Turk Knot End
I03MW	Manila Rope	Whipped End
I04PB	Polypro Rope	Braided Rope End
I04PPB	Polypro Rope	Poly Boot End
I04PTK	Polypro Rope	Turk Knot End
I04PW	Polypro Rope	Whipped End
I05PPB	Polyplus Rope	Braided Rope End
I05PPP	Polyplus Rope	Poly Boot End
I05PTK	Polyplus Rope	Turk Knot End
I05PPW	Polyplus Rope	Whipped End



MODEL 109 ADJUSTABLE HEIGHT CHIN UP BAR is constructed of steel frame rails and welded steel movable bar structure • Bar is 1" diameter and shall adjust to four predetermined heights using keyhole slots • Includes grey powdercoat finish.



MODEL 105 PEG BOARDS are 2" thick hard wood finished with three coats of clear varnish • Two hand-grip pegs are furnished for each board • Pegboards are available in the following sizes: Advanced Elementary (24" x 24"), Junior/Senior HS (28" x 28"), Vertical HS (12" x 72"), and High School/Collegiate (31" x 31")



MODEL 108 ARM LADDER is constructed with 1 5/16" diameter heavy wall tubing • Support frame is fastened to 2" x 6" wood boards sealed and varnished are mounted to the wall on 22" centers • Grid rungs are 1" diameter steel tubing spaced 8" apart • Includes grey powdercoat finish.



MODEL 106 GRID CLIMBER is constructed of 1 5/16" diameter heavy wall tubing • Support frame is fastened to 2" x 6" wood boards sealed and varnished that are mounted to the wall on 31 5/16" centers • Grid rungs are 1" diameter steel tubing • Includes grey powdercoat finish.

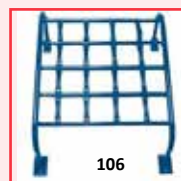

MODEL 104 HORIZONTAL LADDER is constructed of 1 5/8" diameter heavy wall tubing • Support frame is fastened to 2" x 6" wood boards sealed and varnished that are mounted to the wall • Ladder rungs are 1" diameter steel tubing • Includes grey powdercoat finish.



PORTABLE BASKETBALL BACKSTOPS

GARED isn't the premiere manufacturer of portable basketball backstops by accident. Our tradition of quality and innovation began on the drafting tables of our engineering team over 40 years ago, and we haven't looked back since! From our industry changing invention of the Hydra-Goal in 1980, the first ever arena portable system, to our recent introduction of the popular GARED Pro S spring-balanced competition portable, GARED has been continually revolutionizing the portable basketball market. Today, we are proud to offer a full line of competition portable basketball systems, many of which can be seen in professional arenas and NCAA Division I, II & III schools across the U.S., as well as all over the globe. Or maybe you're just looking for a recreational portable for practice sessions or youth leagues? We've got you covered there too - GARED offers a huge assortment of systems for every type of facility and play level. GET IN THE GAME WITH GARED!

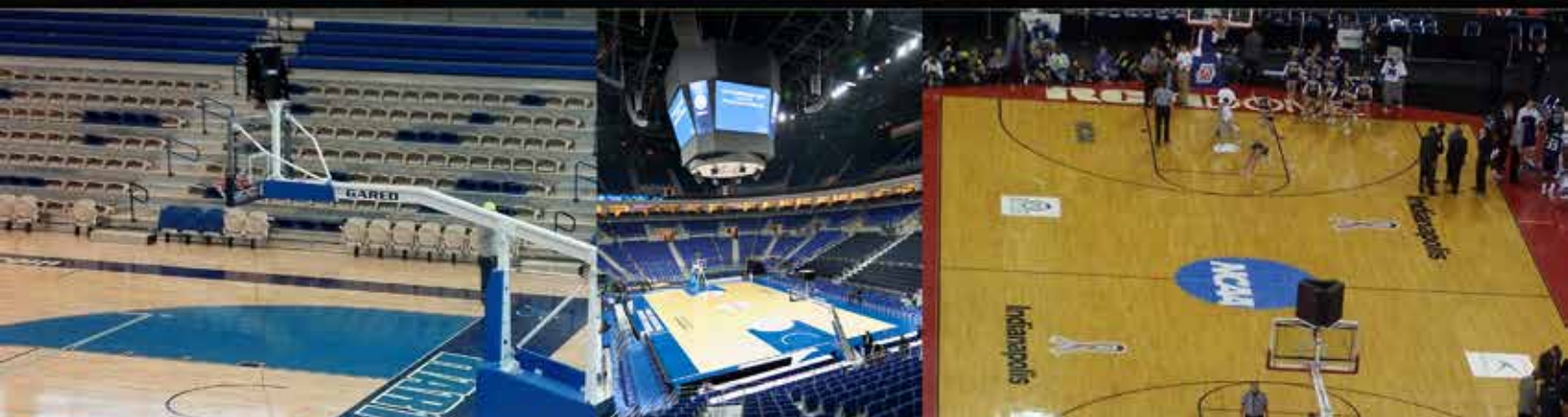

GARED PRO S: SPRING BALANCED COMPETITION PORTABLE

The **GARED PRO S** is the finest engineered competition portable in the world utilizing the GARED tension spring technology • The maintenance-free tension spring mechanism is designed for balanced and effortless lifting/lowering of the unit • The unique mechanism is concealed inside the base for safety and appearance • A superbly designed t-shape extension arm made of fully welded, heavy wall rectangular tubing is patterned after our original GARED Pro H®, which is universally considered the most structurally stable competition portable • The t-shape extension arm and heavy duty uprights eliminate the need for unsightly bridge supports, giving the fans a clear view of the court • Available in 8' and 10' 8" boom extensions for all levels of play and adjustable to 8', 9' and 10' heights • The GARED Pro S comes equipped with an official size (42" x 72") shatter proof glass backboard, our original PRO-MOLD® backboard padding and a positive lock breakaway goal • The base is fully padded on three sides with vinyl covered 2" thick high density polyurethane foam • The front upright is similarly padded to a height of 7' with 5" thick foam • Meets NCAA, NAIA, NFHS and NBA main court specifications and is approved by FIBA for high level international competition • Boom pad and floor anchoring system are included with the unit • Shot clock supports are sold separately • Full weight with ballast 3000 lbs. (1361 kgs) • **10 YEAR LIMITED WARRANTY ON ALL PARTS, LIFETIME LIMITED WARRANTY ON BACKBOARD INCLUDED WITH THE UNIT, 5 YEAR LIMITED WARRANTY ON PRO-MOLD® PADS AND 4 YEAR ON BREAKAWAY GOAL.**

9618: GARED PRO S WITH 10' 8" BOOM

10' 8" BOOM FOR (3.25 M) PORTABLE BASKETBALL BACKSTOP
10 YEAR LIMITED WARRANTY ON ALL PARTS, LIFETIME LIMITED WARRANTY ON BACKBOARD INCLUDED WITH THE UNIT, 5 YEAR LIMITED WARRANTY ON PRO-MOLD® PADS AND 4 YEAR ON BREAKAWAY GOAL
WEIGHT: 3025 LBS. DEDICATED TRUCK

9618WL: GARED PRO S WITH 10' 8" BOOM & WHEEL LIFT

10' 8" BOOM FOR (3.25 M) PORTABLE BASKETBALL BACKSTOP
10 YEAR LIMITED WARRANTY ON ALL PARTS, LIFETIME LIMITED WARRANTY ON BACKBOARD INCLUDED WITH THE UNIT, 5 YEAR LIMITED WARRANTY ON PRO-MOLD® PADS AND 4 YEAR ON BREAKAWAY GOAL
WEIGHT: 3062 LBS. DEDICATED TRUCK

9616: GARED PRO S WITH 8' BOOM

8' BOOM FOR (2.45 M) PORTABLE BASKETBALL BACKSTOP
10 YEAR LIMITED WARRANTY ON ALL PARTS, LIFETIME LIMITED WARRANTY ON BACKBOARD INCLUDED WITH THE UNIT, 5 YEAR LIMITED WARRANTY ON PRO-MOLD® PADS AND 4 YEAR ON BREAKAWAY GOAL
WEIGHT: 2815 LBS. DEDICATED TRUCK

9616WL: GARED PRO S WITH 8' BOOM & WHEEL LIFT

8' BOOM FOR (2.45 M) PORTABLE BASKETBALL BACKSTOP
10 YEAR LIMITED WARRANTY ON ALL PARTS, LIFETIME LIMITED WARRANTY ON BACKBOARD INCLUDED WITH THE UNIT, 5 YEAR LIMITED WARRANTY ON PRO-MOLD® PADS AND 4 YEAR ON BREAKAWAY GOAL
WEIGHT: 2825 LBS. DEDICATED TRUCK



SPOTLIGHT INSTALLATIONS

ARKANSAS STATE UNIVERSITY - JONESBORO, AR
BLUEGRASS STALLIONS LLC - LEXINGTON, KY
BRANDON UNIVERSITY HEALTHY LIVING CENTRE - BRANDON, MB CAN
CALIFORNIA POLYTECHNIC STATE UNIVERSITY - SAN LUIS OBISPO, CA
CAMP LINDERMERE - HENRYVILLE, PA
CARL ALBERT STATE COLLEGE - POTEAU, OK
CENTENNIAL HIGH SCHOOL - ROSWELL, GA
COLEGIO MARISTAS DEL SALVADOR - EL SALVADOR
FAITH CHAPEL CHRISTIAN CENTER - BIRMINGHAM, AL
GLORIA OLYMPIC ARENA - TURKEY
JEFF DAVIS HIGH SCHOOL - HAZELHURST, GA
JOHN BROWN UNIVERSITY - SILOAM SPRINGS, AR
LAKE COUNTRY CHRISTIAN SCHOOL - FORT WORTH, TX
LAUREL MIDDLE SCHOOL - LAUREL, MS
LINCOLN MEMORIAL UNIVERSITY - HARROGATE, TN
LOUISIANA STATE UNIVERSITY - BATON ROUGE, LA
OKALOOSA WALTON COMMUNITY COLLEGE - NICEVILLE, FL
PANGBURN HIGH SCHOOL - PANGBURN, AR
ROBBINS FLOORING - CINCINNATI, OH
SOUTHEAST MISSOURI STATE UNIVERSITY - CAPE GIRARDEAU, MO
SOUTHERN ILLINOIS UNIVERSITY - EDWARDSVILLE, IL
SPARTAK AREA - RUSSIA
ST. JUDE SCHOOL - COSTA RICA
TEXAS STATE TECHNICAL COLLEGE - WACO, TX
UNIVERSITY OF ARKANSAS - FAYETTEVILLE, AR
UNIVERSITY OF TEXAS AT EL PASO - EL PASO, TX
UNIVERSITY OF WYOMING - LARAMIE, WY



FIBA
EQUIPMENT
& VENUE

FIBA (Fédération Internationale de Basketball) hereby declares, by means of certification, that **MODEL 9618 GARED PRO S PORTABLE BASKETBALL BACKSTOPS** fulfill the Competition Level 1 standards and **MODEL**

9616 GARED PRO S PORTABLE BASKETBALL BACKSTOPS

fulfills the Competition Level 3 standards specified in the latest edition of the Equipment & Venue Approval Programme and **GARED** is therefore qualified as an **OFFICIAL TECHNICAL PARTNER**

**9806 QUICK CONNECT™ MOUNTING PLATES**

Allows for quick and easy installation and removal of backboard and goal. (Patent 7967705, 7794342)

**QUICK BOARD PLUMBING ADJUSTMENT**

Allows for quick, easy and accurate plumbing of the backboard for proper play.

**SPRING ASSIST OPERATION**

Spring design allows backstop to be easily lifted in under 10 seconds. Additional spring can be easily installed if shot clock is added.

**SHIPPED WITH BALLAST**

GARED PRO S is shipped with ballast securely enclosed within a welded basin located in back of portable unit's base.

**GARED PRO S FEATURES**

BACKBOARD: Official size 42" x 72" shatter proof rectangular glass backboard (Model LXP4200) with a welded and reinforced steel frame. 1/2" tempered glass with fired in target and border for maximum durability. LED perimeter lights, #2137, are sold separately.

GOAL: Models 3500 and 3500I Master, positive lock breakaway goals come standard with these units for the domestic and international markets respectively. Model 3500I Master meets all FIBA standards. Other breakaway goals are optional and available upon request.

PADDING: Durable GARED PRO-MOLD® backboard edge padding comes in a wide variety of colors. Standard color for system padding is royal blue; other standard colors are available at no additional cost. Custom logos for the front and side pads are available at an additional cost.

BALLAST: 1200 lbs. (544 kgs.) of enclosed ballast concealed in the base of the unit, welded closed.

HEIGHT ADJUSTABLE: Unique telescoping brace allows for preset heights of 8', 9' and 10'. Custom heights are available upon request.

ADJUSTABLE FLOOR PADS: Two floor pads are enclosed in steel supports for added stability, and are controlled by a screw-type mechanism that raises the unit off the wheels and adjusts the unit to exactly 10' height.

FLOOR ANCHORING SYSTEM: Floor anchors and locater pins are included as standard. Specify floor type.

FINISH: The unit is powdercoated white. Other colors are available at additional cost.

SHOT CLOCK & CAMERA SUPPORTS: Available at a nominal cost. Specify shot clock type.

TRANSPORT & STORAGE: Folds easily for compact storage with non-marking polyurethane casters for easy transport.

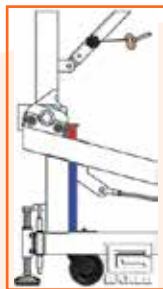
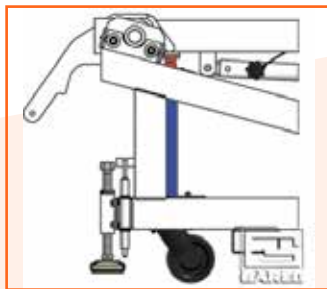
**9621: AUTOMATIC FRONT WHEEL LIFT SYSTEM**

This optional system is designed to make the basic installation and set up of the **GARED PRO S** effortless. It eliminates the need to adjust the leveling pads by automatically lifting the front wheels off the ground when the boom is raised to the play position and lower them when the boom is lowered to the folded or stored position. As the portable is raised, a cam operated mechanism raises the front wheels off the floor causing the boom to lock in the play position and the base to rest evenly on the supporting frame. Conversely, when the wheels are in the down position the portable can be moved around.

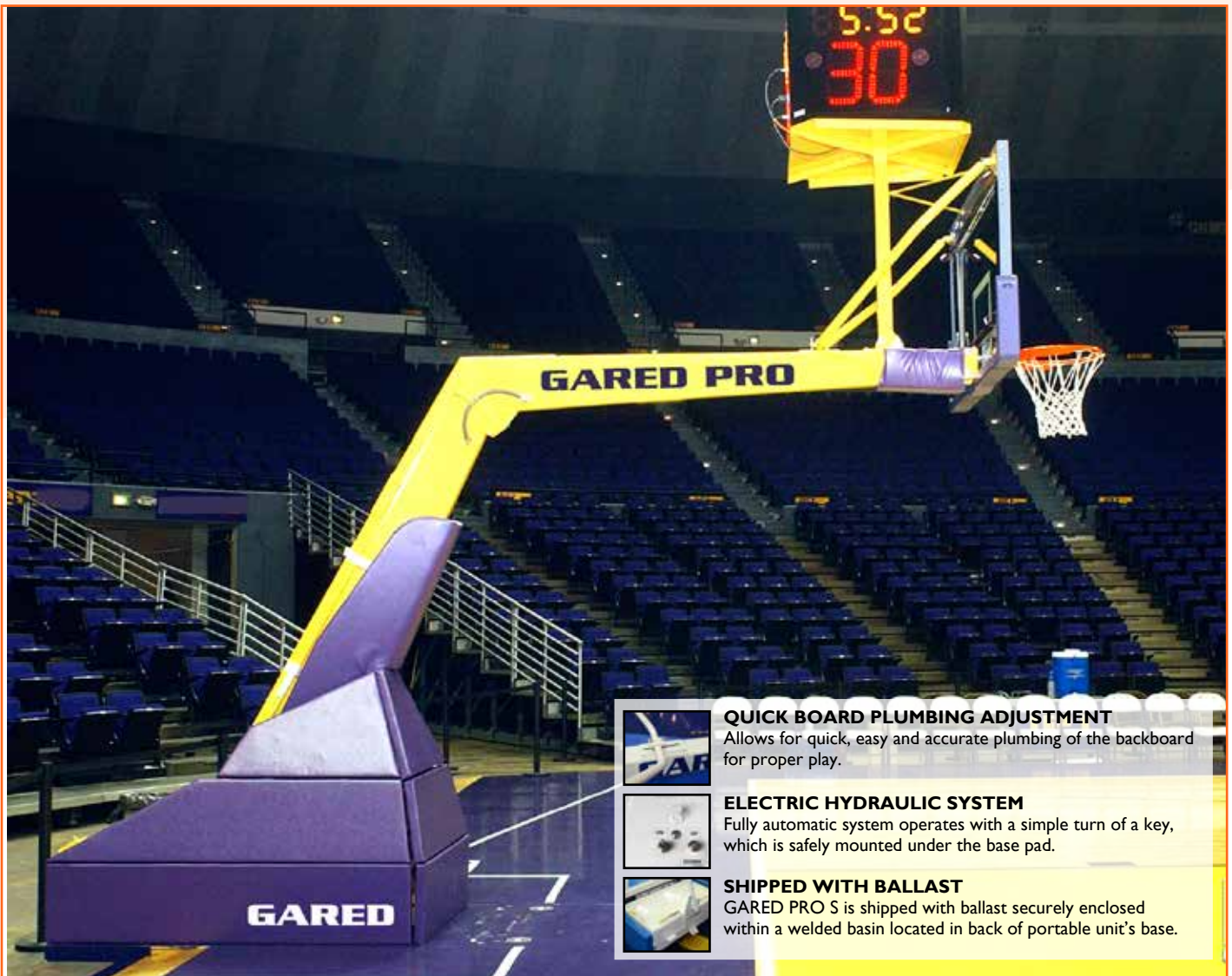

QUICK BOARD PLUMBING ADJUSTMENT

Allows for quick, easy and accurate plumbing of the backboard for proper play.



ELECTRIC HYDRAULIC SYSTEM

Fully automatic system operates with a simple turn of a key, which is safely mounted under the base pad.



SHIPPED WITH BALLAST

GARED PRO S is shipped with ballast securely enclosed within a welded basin located in back of portable unit's base.

GARED PRO H

The **GARED PRO H** is the flagship of the GARED family of portable basketball backstops, and is by far the best competition basketball backstop in the industry • Uniquely engineered, it has been the portable of choice of many professional teams and colleges throughout the world • Tapered, laser cut, trapezoidal extension arm and mast provide ultimate backboard stability, meeting the most demanding requirements for professional competition play • The unit is raised and lowered with a state-of-art, electric-hydraulic system designed to be totally reliable and trouble free • Available in 8' and 10' 8" boom extensions, the GARED PRO H comes equipped with an official size (42" x 72") shatter proof glass backboard, our original PRO-MOLD® backboard padding, and a positive lock breakaway goal • The base is fully padded on three sides with vinyl covered 2" thick high density polyurethane foam • The front upright is similarly padded to a height of 7' with 2" thick foam • Meets NCAA, NAIA, NFHS and NBA main court specifications and is approved by FIBA for high level international competition • Boom pad and floor anchoring system are included with the unit • Shot clock supports are sold separately • Full weight with ballast 3100 lbs. (1406 .kgs) • **10 YEAR LIMITED WARRANTY ON ALL PARTS, LIFETIME LIMITED WARRANTY ON BACKBOARD INCLUDED WITH THE UNIT, 5 YEAR LIMITED WARRANTY ON PRO-MOLD® PADS AND 4 YEAR ON BREAKAWAY GOAL.**

5018: GARED PRO H WITH 10' 8" BOOM

10' 8" BOOM FOR (3.25 M) PORTABLE BASKETBALL BACKSTOP
10 YEAR LIMITED WARRANTY ON ALL PARTS, LIFETIME LIMITED WARRANTY ON BACKBOARD INCLUDED WITH THE UNIT, 5 YEAR LIMITED WARRANTY ON PRO-MOLD® PADS AND 4 YEAR ON BREAKAWAY GOAL
WEIGHT: 3300 LBS. DEDICATED TRUCK

5016: GARED PRO H WITH 8' BOOM

8' BOOM FOR (2.45 M) PORTABLE BASKETBALL BACKSTOP
10 YEAR LIMITED WARRANTY ON ALL PARTS, LIFETIME LIMITED WARRANTY ON BACKBOARD INCLUDED WITH THE UNIT, 5 YEAR LIMITED WARRANTY ON PRO-MOLD® PADS AND 4 YEAR ON BREAKAWAY GOAL
WEIGHT: 3100 LBS. DEDICATED TRUCK



FIBA
EQUIPMENT
& VENUE

FIBA (Fédération Internationale de Basketball) hereby declares, by means of certification, that **MODEL 5018 GARED PRO H PORTABLE BASKETBALL BACKSTOPS** fulfill the Competition

Level 1 standards and **MODEL 5016 GARED PRO H PORTABLE BASKETBALL BACKSTOPS** fulfill the Competition Level 3 standards specified in the latest edition of the Equipment & Venue Approval Programme and **GARED** is therefore qualified as an **OFFICIAL TECHNICAL PARTNER.**

GARED PRO H FEATURES

BACKBOARD: Model LXP4200 - official size 42" x 72" shatter proof rectangular glass backboard with a welded and reinforced steel frame. 1/2" tempered glass with fired in target and border for maximum durability. LED perimeter lights, #2137, are sold separately.

GOAL: Models 3500 and 3500I Master, positive lock breakaway goals come standard with these units for the domestic and international markets respectively. Model 3500I Master meets all FIBA standards. Other breakaway goals are optional and available upon request.

PADDING: Durable GARED PRO-MOLD® backboard edge padding comes in a wide variety of colors. Standard color for system padding is royal blue; other standard colors are available at no additional cost. Custom logos for the front and side pads are available at an additional cost.

BALLAST: 1000 lbs. (455 kgs.) of enclosed ballast concealed in the base of the unit, welded closed.

ELECTRIC-HYDRAULIC SYSTEM: Simple to operate. Automatically controls folding and lifting of the unit with the turn of a key. Available for domestic and international power supply.

FLOOR ANCHORING SYSTEM: Floor anchors and locater pins are included as standard. Specify floor type.

FINISH: The unit is powdercoated white. Other colors are available at additional cost.

SHOT CLOCK & CAMERA SUPPORTS: Available at a nominal cost. Specify shot clock type.

TRANSPORT & STORAGE: Folds easily for compact storage with two 6" front and two 10" rear wide non-marking polyurethane casters for easy transport.

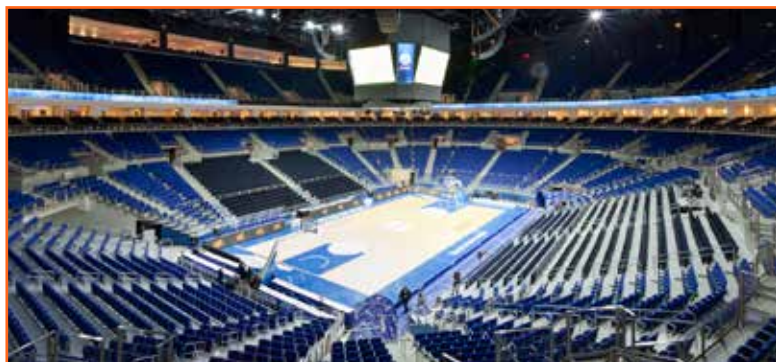
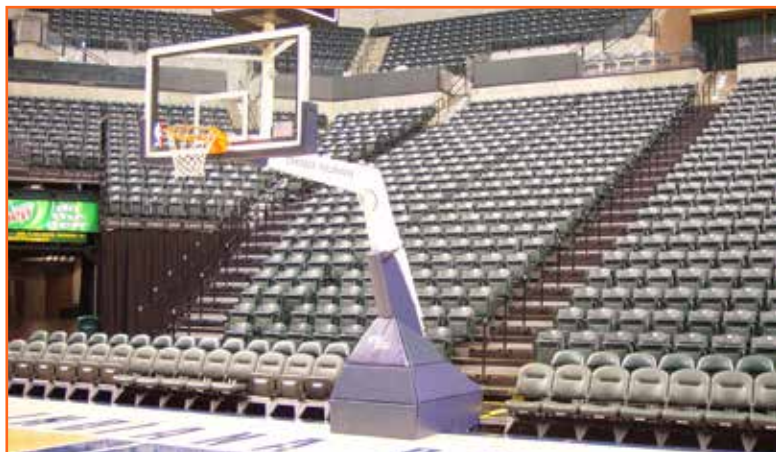

SPOTLIGHT INSTALLATIONS

- 2015 PAN AM GAMES - TORONTO, ONTARIO
- BALL STATE UNIVERSITY - MUNCIE, IN
- BANK OF AMERICA CENTER - BOISE, ID
- BARNETT STADIUM - HOUSTON, TX
- BOWLING GREEN HIGH SCHOOL - BOWLING GREEN, KY
- CHINESE BASKETBALL ALLIANCE - TAIWAN, REPUBLIC OF CHINA
- CHICAGO BULLS PRACTICE FACILITY - CHICAGO, IL
- EDWARD JONES DOME - ST. LOUIS, MO
- GORDON COLLEGE - WENHAM, CO
- LOUISIANA SUPERDOME - NEW ORLEANS, LA
- LOUISIANA STATE UNIVERSITY - BATON ROUGE, LA
- LOYOLA MARYMOUNT UNIVERSITY - LOS ANGELES, CA
- MAC PHERSON STADIUM - HONG KONG
- NATIONAL CAR RENTAL CENTER - FORT LAUDERDALE, FL
- NORTH CAROLINA CENTRAL UNIVERSITY - DURHAM, NC
- PARK CITY RACQUET CLUB - PARK CITY, UT
- TENNESSEE TECH UNIVERSITY - COOKEVILLE, TN
- TEXAS SOUTHERN UNIVERSITY - HOUSTON, TX
- TRI-STATE UNIVERSITY - ANGOLA, IN
- TRINIDAD HIGH SCHOOL - TRINIDAD, CO
- SUSQUEHANNA CENTER - BEL AIR, MD
- UNIVERSITY OF EVANSVILLE - EVANSVILLE, IN
- UNIVERSITY OF FINDLAY - FINDLAY, OH
- VISUAL CONCEPTS ENTERTAINMENT - NOVATO, CA
- WORLD HARVEST BIBLE COLLEGE - CANAL WINCHESTER, OH

GARED PRO S, GARED PRO H & HOOPMASTER FLOOR ANCHOR GUIDE

ANCHOR STYLE	STYLE B	STYLE BX	STYLE C	STYLE E
	<p>STYLE B ANCHORS are used on wood floors when one layer of wood is directly on concrete.</p> <p>STYLE B ANCHORS are also used on portable wood basketball floors such as arena floors that are 3" or more thick for anchoring GARED portable units.</p>	<p>STYLE BX ANCHORS are used on wood floor when the floor is over a subfloor directly on concrete.</p>	<p>STYLE C ANCHORS are used of concrete floors on synthetic floors.</p>	<p>STYLE E ANCHORS are used on permanent style floating floors.</p> <p>STYLE E is not recommended for portable floating floors such as arena floors because of the permanent location of the anchor. However, if requested by the customer, the style E could be used on portable arena floors.</p>

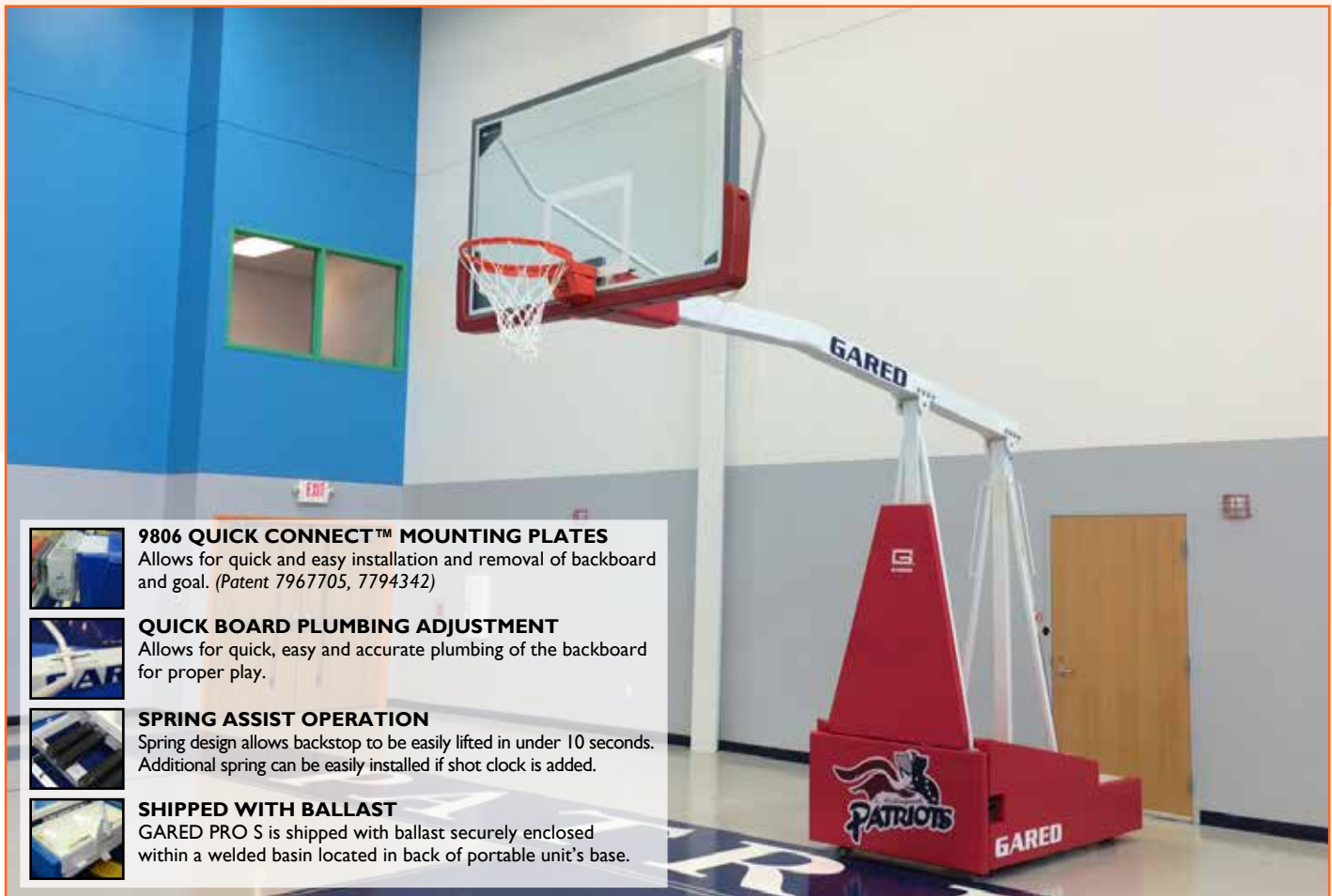

9806 QUICK CONNECT™ MOUNTING PLATES

Allows for quick and easy installation and removal of backboard and goal. (Patent 7967705, 7794342)



QUICK BOARD PLUMBING ADJUSTMENT

Allows for quick, easy and accurate plumbing of the backboard for proper play.

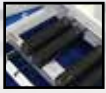

SPRING ASSIST OPERATION

Spring design allows backstop to be easily lifted in under 10 seconds. Additional spring can be easily installed if shot clock is added.



SHIPPED WITH BALLAST

GARED PRO S is shipped with ballast securely enclosed within a welded basin located in back of portable unit's base.

HOOPMASTER®: MOST VERSATILE SPRING BALANCED PORTABLE BASKETBALL BACKSTOP SYSTEM

This state-of-art portable basketball system uses the GARED tension spring technology for easy use and operation • The maintenance-free tension spring mechanism has been engineered for balanced and effortless lifting and lowering of the unit and the springs are concealed inside the base for safety and appearance • The Hoopmaster® is designed for main court play in university, high school and professional arenas • It is ideal for all side court play and it is approved by FIBA for level 3 international competition • Available in 8' boom extensions for all levels of play and adjustable at 8', 9' and 10' heights • The Hoopmaster® comes with an official size (42" x 72") shatter proof glass backboard, our original PRO-MOLD® backboard padding, and a positive lock breakaway goal • The base is fully padded on three sides with vinyl covered high density polyurethane foam • The front is similarly padded to a height of 7'. Boom pad and anchoring system are included with the unit • Shot clock supports are sold separately • Full weight with ballast 2200 lbs. (998 kgs) •

10 YEAR LIMITED WARRANTY ON ALL PARTS, LIFETIME LIMITED WARRANTY ON BACKBOARD INCLUDED WITH THE UNIT, 5 YEAR LIMITED WARRANTY ON PRO-MOLD® PADS AND 4 YEAR ON BREAKAWAY GOAL.

9408: GARED HOOPMASTER®8 WITH 8' BOOM

8' BOOM FOR (2.45 M) PORTABLE BASKETBALL BACKSTOP
10 YEAR LIMITED WARRANTY ON ALL PARTS, LIFETIME LIMITED WARRANTY ON BACKBOARD INCLUDED WITH THE UNIT, 5 YEAR LIMITED WARRANTY ON PRO-MOLD® PADS AND 4 YEAR ON BREAKAWAY GOAL
WEIGHT: 2405 LBS. DEDICATED TRUCK

9405: GARED HOOPMASTER®5 WITH 5' BOOM

5' BOOM FOR (1.5 M) PORTABLE BASKETBALL BACKSTOP
10 YEAR LIMITED WARRANTY ON ALL PARTS, LIFETIME LIMITED WARRANTY ON BACKBOARD INCLUDED WITH THE UNIT, 5 YEAR LIMITED WARRANTY ON PRO-MOLD® PADS AND 4 YEAR ON BREAKAWAY GOAL
WEIGHT: 2392 LBS. DEDICATED TRUCK

HOOPMASTER® FEATURES

BACKBOARD: Official size 42" x 72" tempered glass backboard with a welded reinforced powdercoated steel frame (Model LXP4200). 1/2" tempered glass with fired in target and border for maximum durability. LED perimeter lights, #2137, are sold separately.

GOAL: Models 2500 Collegiate and 2500I Tournament, positive lock breakaway goals come standard with these units for the domestic and international markets, respectively. Other breakaway goals are optional and available upon request.

PADDING: Durable GARED PRO-MOLD® backboard edge padding comes in a wide variety of colors. Standard color for system padding is royal blue; other standard colors are available at no additional cost. Custom logos for the front and side pads are available at an additional cost.

BALLAST: 1000 lbs. (455 kgs.) of enclosed ballast concealed in the base of the unit, welded closed.

HEIGHT ADJUSTABLE: Unique telescoping brace allows for preset heights of 8', 9' and 10'. Custom heights are available upon request.

ADJUSTABLE FLOOR PADS: Two floor pads are encased in steel supports for added stability, and are controlled by a screw-type mechanism that raises the unit off the wheels and adjusts the unit to exactly 10' height.

FLOOR ANCHORING SYSTEM: Floor anchors and locator pins are included as standard. Specify floor type.

FINISH: The unit is powdercoated white. Other colors are available at additional cost.

TRANSPORT & STORAGE: Folds easily for compact storage with single non-marking polyurethane casters for easy transport.



GARED HOOPMASTER® LT: THE PORTABLE OF CHOICE FOR SIDE COURTS, OUTDOOR COMPETITION AND INTRAMURAL PLAY

The traditional style of the **GARED HOOPMASTER® LT** offers more features and structural strengths than any similar size basketball portable backstop available on the market • A unique tension spring mechanism allows for effortless lifting and lowering of the unit • Adjustable at 8', 9' and 10' heights, the portable comes with an official size (42" x 72") shatter proof glass backboard, our original PRO-MOLD® backboard padding, and a positive lock breakaway goal • The base is fully padded on three sides with vinyl covered high density polyurethane foam • An anchoring system is included with the unit • Full weight with ballast 1700 lbs. (771 kgs) • **10 YEAR LIMITED WARRANTY ON ALL PARTS, LIFETIME LIMITED WARRANTY ON BACKBOARD INCLUDED WITH THE UNIT, 10 YEAR LIMITED WARRANTY ON PRO-MOLD® PADS AND 4 YEAR ON BREAKAWAY GOAL** • PLEASE NOTE: OUTDOOR USE AND STORAGE OF THE HOOPMASTER LT VOIDS WARRANTY • OUTDOOR USE REQUIRES GALVANIZED UPCHARGE FINISHING.

9305: GARED HOOPMASTER® LT WITH 5' BOOM 5' 6" BOOM FOR (1.68 M) PORTABLE BASKETBALL BACKSTOP 10 YEAR LIMITED WARRANTY ON ALL PARTS, TWO YEAR WARRANTY ON BACKBOARD INCLUDED WITH THE UNIT, 5 YEAR LIMITED WARRANTY ON PRO-MOLD® PADS AND 4 YEAR ON BREAKAWAY GOAL WEIGHT: 1700 LBS. DEDICATED TRUCK

HOOPMASTER LT® FEATURES

BACKBOARD: Model BB72G50 official size 42" x 72", 1/2" tempered glass backboard with a welded reinforced powdercoated steel frame. Limited Lifetime Warranty on backboards. 60" glass and acrylic backboards are optional and available upon request.

GOAL: 2000+ Collegiate breakaway goal

PADDING: Durable GARED PRO-MOLD® backboard edge padding comes in a wide variety of colors. Standard color for system padding is royal blue; other standard colors are available at no additional cost. Custom logos for the front and side pads are available at an additional cost.

BALLAST: 950 lbs. (432 kgs.) of enclosed ballast concealed in the base of the unit, welded closed.

HEIGHT ADJUSTABLE: Unique telescoping brace allows for preset heights of 8', 9' and 10'.

FLOOR ANCHORING SYSTEM: Tie down anchor system included. Optional inground anchor can be purchased separately, please specify floor type.

FINISH: The unit is powdercoated white. Other colors are available at additional cost.

TRANSPORT & STORAGE: Folds easily for compact storage with single non-marking polyurethane casters for easy transport. Cannot be stored outside. Outside play and storage voids warranty.



GARED HOOPMASTER SPOTLIGHT INSTALLATIONS

ANDREWS HIGH SCHOOL - ANDREWS, TX
 ASCENSION CHRISTIAN HIGH SCHOOL - GONZALES, LA
 BARDSTOWN HIGH SCHOOL - BARDSTOWN, KY
 CAMPBELLSVILLE UNIVERSITY - CAMPBELLSVILLE, KY
 CAMP FRENCH WOODS FOR PERFORMING ARTS - HANCOCK, NY
 EPISCOPAL HIGH SCHOOL - ALEXANDRIA, VA
 FUNDAMENTAL SPORTS TRAINING INC. - WESTBURY, NY
 FRANKLIN READINESS CENTER - FRANKLIN, IN
 HILLSDALE UNITED BRETHEN CHURCH - HILLSDALE, MI
 NIKE TOURNAMENT OF CHAMPIONS - CHICAGO, IL
 NORTH VALLEY BAPTIST CHURCH - SANTA CLARA, CA
 PERFORMANCE CENTER - OKLAHOMA CITY, OK
 RED STUDIOS HOLLYWOOD - LOS ANGELES, CA
 SAINT ELIZABETH COLLEGE - MORRISTOWN, NJ



SENDAI BASKETBALL DOME - JAPAN
 SILVER SPURS ARENA - KISSIMMEE, FL
 STEPHENS COUNTY HIGH SCHOOL - TOCCOA, GA
 TEXAS SOUTHERN UNIVERSITY - HOUSTON, TX
 WARABI CITIZEN GYMNASIUM - JAPAN



GARED HOOPMASTER LT SPOTLIGHT INSTALLATIONS

ARCHIE R-V SCHOOL - ARCHIE, MO
 BASKETBALL ASSOCIATION - BEQUIA ISLAND
 COLEMAN COUNTRY DAY CAMP - FREEPORT, NY
 EASTERN WASHINGTON UNIVERSITY - CHENEY, WA
 FAITH ACADEMY - MOBILE, AL
 FOREST HILLS ELEMENTARY SCHOOL - FLORENCE, AL
 FORT WASHAKIE BOYS & GIRLS CLUB - FORT WASHAKIE, WY
 INDIANA BASKETBALL ACADEMY - INDIANAPOLIS, IN
 JAM ON IT - RENO, NV
 QASSIM UNIVERSITY - SAUDI ARABIA
 SCHEU FAMILY YMCA OF UPLAND - UPLAND, CA



The **GARED HOOPMASTER® C72 AND R54** are versatile portable basketball backstops sporting competition quality glass backboard and breakaway rim combinations • They are a perfect fit for facilities with court space limitations • Ideal play environments include school gymnasiums, churches, side court placement and for practice, club level and recreational league play • Sized to fit through standard double door for easy portability and storage • Spring assisted height mechanism to ease the play position of unit • Locator pin and anchoring pins available for ultimate stability.

9172: HOOPMASTER® C72, PORTABLE BASKETBALL BACKSTOP SYSTEM WITH 5' EXTENSION BOOM & 72" BACKBOARD

10 YEAR LIMITED WARRANTY ON ALL PARTS, 2 YEAR LIMITED WARRANTY ON BACKBOARD INCLUDED WITH THE UNIT, 5 YEAR LIMITED WARRANTY ON PRO-MOLD® PADS AND 4 YEAR ON BREAKAWAY GOAL
WEIGHT: 1555 LBS. TRUCK, FREIGHT CLASS 150, 24 HOUR SHIP

9154: HOOPMASTER® R54, PORTABLE BASKETBALL BACKSTOP SYSTEM WITH 5' EXTENSION BOOM & 54" BACKBOARD

10 YEAR LIMITED WARRANTY ON ALL PARTS, 2 YEAR LIMITED WARRANTY ON BACKBOARD INCLUDED WITH THE UNIT, 5 YEAR LIMITED WARRANTY ON PRO-MOLD® PADS AND 4 YEAR ON BREAKAWAY GOAL
WEIGHT: 1555 LBS. TRUCK, FREIGHT CLASS 150, 24 HOUR SHIP

HOOPMASTER® C72 AND R54 FEATURES

BACKBOARD: MODEL 9172 features 42" x 72" glass backboard (Model: BB72G50); MODEL 9154 features 42" x 54" glass backboard (Model: 3050)

GOAL: 2000+ Collegiate breakaway goal.

PADDING: Durable GARED PRO-MOLD® recreational backboard edge padding comes in a wide variety of colors. Standard color for system padding is black

BALLAST: 600 lbs. of enclosed ballast concealed in the base of the unit.

HEIGHT ADJUSTABLE: Unique telescoping brace allows for preset heights of 8', 9' and 10'.

FINISH: The unit is powdercoated white. Other colors are available at additional cost.

TRANSPORT & STORAGE: Folds easily for compact storage with single non-marking polyurethane casters for easy transport. Two 4" front casters and one 3" rear-swivel caster.

The **GARED SUPER-Z60 AND Z54** are designed for institutional as well as recreational play in schools, churches, training and fitness facilities • Compact frame and large wheels make these portable backstops easy to roll around and store in area with limited space • Sized to fit through standard double door, for easy portability and storage • Spring assisted height mechanism to ease the play position of unit.

9060: GARED SUPER-Z60 BASKETBALL BACKSTOP SYSTEM WITH 60" BACKBOARD

2 YEAR LIMITED WARRANTY ON ALL PARTS, 1 YEAR LIMITED WARRANTY ON BACKBOARD INCLUDED WITH THE UNIT, AND 2 YEAR LIMITED ON BREAKAWAY GOAL, WEIGHT: 1008 LBS. TRUCK, FREIGHT CLASS 150, 24 HOUR SHIP

9054: GARED SUPER-Z54 BASKETBALL BACKSTOP SYSTEM WITH 54" BACKBOARD

2 YEAR LIMITED WARRANTY ON ALL PARTS, 1 YEAR LIMITED WARRANTY ON BACKBOARD INCLUDED WITH THE UNIT, AND 2 YEAR LIMITED ON BREAKAWAY GOAL, WEIGHT: 1008 LBS. TRUCK, FREIGHT CLASS 150, 24 HOUR SHIP

SUPER-Z60 AND Z54 FEATURES

BACKBOARD: MODEL 9060 features 36" x 60" acrylic backboard (Model: GP6036); MODEL 9054 features 36" x 54" acrylic backboard (Model: GP5432)

GOAL: 1000 Scholastic flex breakaway goal.

PADDING: Durable GARED PRO-MOLD® recreational black backboard edge padding, BALLAST: Ballast supplied by customer.

HEIGHT ADJUSTABLE: Unique telescoping brace allows for preset heights of 8', 9' and 10'.

FINISH: The unit is powdercoated white. Other colors are available at additional cost.

TRANSPORT & STORAGE: Folds easily for compact storage with single non-marking polyurethane casters for easy transport. Two 4" front casters and one 3" rear-swivel caster.





The **MICRO-Z54™** is the first of its kind and the most popular roll-around portable backstop system for the past 30 years • This highly portable system rolls easily on four large casters and locks in place with the flip of a brake lever • Great for all ages and skill levels and priced for any budget • It is designed for side court and multipurpose recreational areas • Available with 54" backboard & breakaway rim • This portable is not recommended for main court use or dunking activities • **PLEASE NOTE: OUTDOOR USE AND STORAGE OF THE MICRO-Z54 VOIDS WARRANTY.**

MICRO-Z54™: ROLL-AROUND BASKETBALL BACKSTOP WITH 54" ACRYLIC BACKBOARD & BREAKAWAY RIM

2 YEAR LIMITED WARRANTY, WEIGHT: 395 LBS. (180 KGS), TRUCK, FREIGHT CLASS 150, 24 HOUR SHIP

BACKBOARD: 32" x 54" acrylic backboard (Model: GP5432)

GOAL: 724 breakaway goal.

PADDING: Fully padded with high density polyurethane foam covered with non-tearing 14 oz. black vinyl. *Optional LSCE backboard padding not included.*

BALLAST: 250 lbs. (114 Kgs.) of ballast required and concealed in the base of the unit. Provided by customer.

HEIGHT ADJUSTABLE: Spring assisted unit adjusts from 7' juniors' to 10' regulation heights.

The **MINI-EZ™** is designed to provide rugged durability for home, club or church use • This highly portable system rolls easily on four large casters and sets in place with the flip of a lever • It features heavy duty steel construction and direct mount goal design • It folds down to 48" W x 80 1/2" H x 62" L -including board & goal • This portable is not recommended for main court use or dunking activities • **PLEASE NOTE: OUTDOOR USE AND STORAGE OF THE MINI-EZ VOIDS WARRANTY.**

MINI-EZ™: ROLL-AROUND BASKETBALL BACKSTOP

2 YEAR LIMITED WARRANTY, WEIGHT: 290 LBS. (148 KGS), TRUCK, FREIGHT CLASS 150, 24 HOUR SHIP

BACKBOARD: GP4832ISQ 48" x 32" rectangular acrylic backboard with 3/8" thickness affixed to a superior 1" welded aluminum uni-frame.

GOAL: 26WO standard stationary goal with nylon net.

PADDING: Fully padded with high density polyurethane foam covered with non-tearing 18 oz. black vinyl. *Optional LSCE backboard padding not included.*

BALLAST: 250 lbs. (114 Kgs.) of ballast required and concealed in the base of the unit. Provided by customer.

HEIGHT ADJUSTABLE: Spring assisted unit adjusts from 7' juniors' to 10' regulation heights.



GARED HOOPS 21™: THE PROVEN 3-ON-3 TOURNAMENT PORTABLE BACKSTOP

The **GARED HOOPS 21™** offers a computer designed, black powdercoated, unitized frame making it the strongest, most portable 3-on-3 basketball tournament system on the market • Designed for indoor/outdoor use, it is adjustable at 8', 9' and 10' heights • It is totally collapsible and folds easily into a flat, compact storage position that can be rolled away • This portable unit comes with a beefy fan-shape 39" x 54" fiberglass backboard • A 2" thick high density polyurethane foam front pad covered with 18 oz. black vinyl is included for added player protection • A minimum of 300 lbs of ballast is required • Vinyl bags that can be filled with sand are included with the unit.

9249: HOOPS 21™: "3 ON 3" PORTABLE BASKETBALL BACKSTOP WITH 54" X 39" FAN-SHAPE FIBERGLASS BACKBOARD

1 YEAR LIMITED WARRANTY, WEIGHT: 250LBS. (100KGS), TRUCK, FREIGHT CLASS 150, 24 HOUR SHIP

BACKBOARD: Model 1301B fan-shape fiberglass backboard.

GOAL: Model 39WO institutional fixed goal is standard with the unit.

PADDING: Fully padded with 2" thick high density polyurethane foam covered with non-tearing 18 oz. black vinyl for added player protection.

BALLAST: Vinyl bags that can be filled with sand come standard with this portable unit; 300 lbs of ballast recommended. Provided by customer.

HEIGHT ADJUSTABLE: The unit can be easily adjusted to 8', 9' and 10' heights.

FINISH: Entire system powdercoated black.

TRANSPORT & STORAGE: Folds completely into a compact storage position that can be easily lifted and rolled away.



Minimize tournament installation time while maximizing court and shipping space with **GARED'S SPACE JAM™ TRAVELING TOURNAMENT**

BASKETBALL SYSTEM • Our best innovations are developed from providing play and facility solutions to our customers • We were challenged to create a traveling system that met features of: stability to withstand monster dunks; ability to set up multiple courts without creating sleeves on inside court or outdoor asphalt; transportability of all systems in one truck; easy and quick set-up by 3-men crews • Durable 6" x 6" black powdercoated steel posts are hinged to the weighted base and steadily raised to play position with an electric hoist • Each 6" x 6" square black post features stabilization poles that are adjusted to minimize vibration • GARED's acrylic backboard and breakaway rim are easily attached using our patented Quick Connect system • A 53' foot hauling truck can easily transport 30 complete courts • Each base features forklift slots for system loading.



SPACE JAM™ PORTABLE BASE

Fork lift slots allow for easy transport. Added ballast removes need for sleeves or floor pins.



EASY BASE POST HINGE POINT

Allows for easy securing of the Space Jam™ post to weighted floor base.

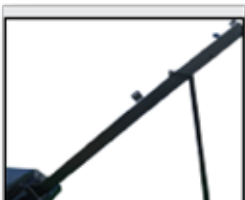

KICKSTAND INSTALL TOOL

Provides stability while attaching 5' extension arm, backboard and goal.



ELECTRIC HOIST WITH REMOTE

Safely and effortlessly raise the Space Jam™ units into play position.



QUICK CONNECT™ MOUNTING PLATE

Allows for quick and easy installation and removal of backboard and goal. (Patent 7967705, 7794342)

SPACE JAM™ FEATURES

BACKBOARD: Features 42" x 72" acrylic backboard (Model: BB72A38)

GOAL: 2000+ Collegiate flex breakaway goal.

PADDING: Durable GARED PRO-MOLD® recreation backboard edge padding in black. Standard color for system padding is black; other standard colors are available at no additional cost. Custom logos for the front are available at an additional cost.

BALLAST: Ballast supplied by customer.

HEIGHT: Unit height set at 10'.

FINISH: The unit is powdercoated black. Other colors are available at additional cost.

TRANSPORT & STORAGE: Units are easily transportable by forklift.

9252: SPACE JAM™ TRAVELING BASKETBALL SYSTEM, DUAL POST

WEIGHT: 1323 LBS, TRUCK, FREIGHT CLASS 150, 2-4 WEEK SHIP

9251: SPACE JAM™ TRAVELING BASKETBALL SYSTEM, SINGLE POST

WEIGHT: 776 LBS, TRUCK, FREIGHT CLASS 150, 2-4 WEEK SHIP

9256: SPACE JAM™ TRAVELING BASKETBALL SYSTEM KICKSTAND INSTALL TOOL

WEIGHT: 34 LBS, TRUCK, FREIGHT CLASS 70, 2-4 WEEK SHIP

9254: SPACE JAM™ TRAVELING BASKETBALL SYSTEM BASE

WEIGHT: 320 LBS, TRUCK, FREIGHT CLASS 70, 2-4 WEEK SHIP

9257: SPACE JAM™ TRAVELING BASKETBALL SYSTEM ELECTRIC HOIST

WEIGHT: 30 LBS, TRUCK, FREIGHT CLASS 70, 2-4 WEEK SHIP

WHEN PURCHASING A GARED PORTABLE BASKETBALL BACKSTOP SYSTEM - CUSTOMERS HAVE AN OPPORTUNITY TO CUSTOMIZE AND UPGRADE THE PORTABLE BACKSTOP.



AVAILABLE UPGRADES & CUSTOMIZATIONS INCLUDE:

- **QUICK CONNECT™ SYSTEM**, Must be purchased with system
- **SHOT CLOCKS**, Must be purchased with system
- **WHEEL LIFT**, Must be purchased with system
- **LED PERIMETER LIGHTS**
- **CUSTOMIZED PORTABLE PADDING**
- **CUSTOMIZED BOOM LETTERING**
- **CAMERA MOUNTS**
- **BACKBOARD & BASKETBALL GOALS & MUCH MORE!**



301 IRG: 42" X 72" PRO OUTERLIMIT™ ALUMINUM UNI-FRAME GLASS BACKBOARD WITH CENTER STRUT, UNCONDITIONAL LIFETIME WARRANTY, 5" X 4 1/2" HOLE SPACING, WEIGHT: 195 LBS, TRUCK, FREIGHT CLASS 85, 24 HOUR SHIP



4000+: GARED 4000+ MDG (MULTI-DIRECTIONAL) BREAKAWAY GOAL
5 YEAR LIMITED WARRANTY ON RIM, 4" X 5" HOLE SPACING, WEIGHT: 30 LBS, GROUND COURIER SERVICE, 24 HOUR SHIP GUARANTEE

Guaranteed to prevent a loss of time, **GARED'S PERIMETER LIGHTS AND LINE OF SHOT CLOCKS** will ensure when a team is closing in on a buzzer beater. Both are easily added to pre-existing systems and synchronize with most industry's scoreboard brands.

2137: PERIMETER LED LIGHT KIT

1 YEAR LIMITED WARRANTY, WEIGHT: 115 LBS, GROUND COURIER SERVICE, 24 HOUR SHIP

Choose reliability and quality when you opt for one of our super bright **LED SHOT CLOCKS!** • Rated for 100,000 hours of continual usage, our shot clocks require no maintenance and never any light bulbs to change • The cabinet is constructed of 22-gauge galvanized steel with a black powdercoat finish for lasting durability • Our clocks operate in synchronization with existing GARED basketball scoreboard cable controller, and can be used with all of the permanent basketball scoreboards that we offer • They can be easily programmed for any time between 0 and 99 seconds • All cable-controlled models include a keyboard controller, plug-in adapter (runs off of scoreboard controller), loud horn, and 100 feet of control cable per clock (permanent models only). **INDOOR USE ONLY.**



GS-200 - BASKETBALL SHOT CLOCKS

5 YEAR LIMITED WARRANTY, WEIGHT: 76 LBS, GROUND COURIER SERVICE, 24 HOUR SHIP

GS-202 - BASKETBALL SHOT CLOCKS WITH GAME TIMER

5 YEAR LIMITED WARRANTY, WEIGHT: 76 LBS, GROUND COURIER SERVICE, 24 HOUR SHIP



Our new optional **QUICK CONNECT™ SYSTEM** includes our specially designed backboard and goal Quick Connect™ Mounting Plates and Cart • The **QUICK CONNECT™ SYSTEM** allows the user to remove and install a backboard and goal in less than three minutes, a task that may typically take in excess of 30 minutes without it • It is a great tool for emergency and normal maintenance of portable basketball backstops because it reduces down time caused by the replacement of either a defective backboard or goal • Using the Quick Connect™ System to remove/install backboards and goals quickly and safely, multipurpose gymnasium operators can now store their basketball portable backstops in areas with narrow entry ways for more effective use of the facility. **(PATENT 7967705, 7794342)**

9800: QUICK CONNECT™ CART

1 YEAR LIMITED WARRANTY, WEIGHT: 375 LBS, TRUCK, FREIGHT CLASS 150, 24 HOUR SHIP

9806: QUICK CONNECT™ MOUNTING PLATE FOR GARED PRO S

9804: QUICK CONNECT™ MOUNTING PLATE FOR GARED HOOPMASTER®

The Quick Connect™ mounting plates are factory installed and must be purchased with the portable units • The cart can be purchased at any time, but for best results we recommend that they are purchased together • One Quick Connect™ Cart can service multiple portable basketball backstops.

STEPS TO REMOVE AND REPLACE (RE-INSTALL) A BACKBOARD & GOAL USING THE GARED QUICK CONNECT™ SYSTEM - THIS PROCESS TAKES APPROXIMATELY THREE MINUTES

1. Lower and secure portable boom to rest position
2. Wheel quick connect™ cart in front & under backboard
3. Raise backboard until it sits on quick connect™ cart
4. Disconnect upper braces from backboard
5. Rotate braces out of the way
6. Disconnect & remove holding pins from mounting plates
7. Raise cart until backboard comes off hinges
8. Lean backboard forward until it sits securely on cart
9. Wheel cart to storage

TO INSTALL A BACKBOARD AND GOAL WITH THE GARED QUICK CONNECT™ SYSTEM, REVERSE STEPS 1-9.



PLAYGROUND & OUTDOOR BASKETBALL EQUIPMENT

Why shouldn't your outdoor basketball court have the same first-class equipment as your indoor court? At GARED, we believe recreational areas, public parks, and other outdoor venues are just as important as indoor facilities in developing the game of basketball! In addition, your outdoor equipment must be able withstand harsh weather elements, possible vandalism, and constant exposure to rigors of demanding public play. No need to worry, because GARED's complete line of outdoor basketball systems provides unparalleled strength, durability, and peace of mind when you need it most - whether you need a full court set up for a local park, or just shooting hoops in your own backyard!





GARED HOOPMASTER® LT: THE PORTABLE OF CHOICE FOR SIDE COURTS, OUTDOOR COMPETITION AND INTRAMURAL PLAY

The traditional style of the **GARED HOOPMASTER® LT** offers more features and structural strengths than any similar size basketball portable backstop available on the market • A unique tension spring mechanism allows for effortless lifting and lowering of the unit • Adjustable at 8', 9' and 10' heights, the portable comes with an official size (42" x 72") shatter proof glass backboard, our original PRO-MOLD® backboard padding, and a positive lock breakaway goal • The base is fully padded on three sides with vinyl covered high density polyurethane foam • An anchoring system is included with the unit • Full weight with ballast 1700 lbs. (771 kgs) • **10 YEAR LIMITED WARRANTY ON ALL PARTS, LIFETIME LIMITED WARRANTY ON BACKBOARD INCLUDED WITH THE UNIT, 10 YEAR LIMITED WARRANTY ON PRO-MOLD® PADS AND 4 YEAR ON BREAKAWAY GOAL • PLEASE NOTE: OUTDOOR USE AND STORAGE OF THE HOOPMASTER LT VOIDS WARRANTY • OUTDOOR USE REQUIRES GALVANIZED UPCHARGE FINISHING.**

9305: GARED HOOPMASTER® LT WITH 5' BOOM
5' 6" BOOM FOR (1.68 M) PORTABLE BASKETBALL BACKSTOP
10 YEAR LIMITED WARRANTY ON ALL PARTS, TWO YEAR WARRANTY ON BACKBOARD INCLUDED WITH THE UNIT, 5 YEAR LIMITED WARRANTY ON PRO-MOLD® PADS AND 4 YEAR ON BREAKAWAY GOAL
WEIGHT: 1700 LBS. DEDICATED TRUCK

HOOPMASTER LT® FEATURES

BACKBOARD: Model BB72G50 official size 42" x 72", 1/2" tempered glass backboard with a welded reinforced powdercoated steel frame. Limited Lifetime Warranty on backboards. 60" glass and acrylic backboards are optional and available upon request.

GOAL: 2000+ Collegiate breakaway goal

PADDING: Durable GARED PRO-MOLD® backboard edge padding comes in a wide variety of colors. Standard color for system padding is royal blue; other standard colors are available at no additional cost. Custom logos for the front and side pads are available at an additional cost.

BALLAST: 950 lbs. (432 kgs.) of enclosed ballast concealed in the base of the unit, welded closed.

HEIGHT ADJUSTABLE: Unique telescoping brace allows for preset heights of 8', 9' and 10'.

FLOOR ANCHORING SYSTEM: Tie down anchor system included. Optional inground anchor can be purchased separately, please specify floor type.

FINISH: The unit is powdercoated white. Other colors are available at additional cost.

TRANSPORT & STORAGE: Folds easily for compact storage with single non-marking polyurethane casters for easy transport. Cannot be stored outside. Outside play and storage voids warranty.

GARED HOOPS 21™: THE PROVEN 3-ON-3 TOURNAMENT PORTABLE BACKSTOP

The **GARED HOOPS 21™** offers a computer designed, black powdercoated, unitized frame making it the strongest, most portable 3-on-3 basketball tournament system on the market • Designed for indoor/outdoor use, it is adjustable at 8', 9' and 10' heights • It is totally collapsible and folds easily into a flat, compact storage position that can be rolled away • This portable unit comes with a beefy fan-shape 39" x 54" fiberglass backboard • A 2" thick high density polyurethane foam front pad covered with 18 oz. black vinyl is included for added player protection • A minimum of 300 lbs of ballast is required • Vinyl bags that can be filled with sand are included with the unit.

9249: HOOPS 21™: "3 ON 3" PORTABLE BASKETBALL BACKSTOP WITH 54" X 39" FAN-SHAPE FIBERGLASS BACKBOARD
1 YEAR LIMITED WARRANTY, WEIGHT: 250LBS. (100KGS), TRUCK, FREIGHT CLASS 150, 24 HOUR SHIP

BACKBOARD: Model I301B fan-shape fiberglass backboard.

GOAL: Model 39WO institutional fixed goal is standard with the unit.

PADDING: Fully padded with 2" thick high density polyurethane foam covered with non-tearing 18 oz. black vinyl for added player protection.

BALLAST: Vinyl bags that can be filled with sand come standard with this portable unit; 300 lbs of ballast recommended. Provided by customer.

HEIGHT ADJUSTABLE: The unit can be easily adjusted to 8', 9' and 10' heights.

FINISH: Entire system powdercoated black.

TRANSPORT & STORAGE: Folds completely into a compact storage position that can be easily lifted and rolled away.





The **MICRO-Z54™** is the first of its kind and the most popular roll-around portable backstop system for the past 30 years • This highly portable system rolls easily on four large casters and locks in place with the flip of a brake lever • Great for all ages and skill levels and priced for any budget • It is designed for side court and multipurpose recreational areas • Available with 54" backboard & breakaway rim • This portable is not recommended for main court use or dunking activities • **PLEASE NOTE: OUTDOOR USE AND STORAGE OF THE MICRO-Z54 VOIDS WARRANTY.**

MICRO-Z54™: ROLL-AROUND BASKETBALL BACKSTOP WITH 54" ACRYLIC BACKBOARD & BREAKAWAY RIM

2 YEAR LIMITED WARRANTY, WEIGHT: 395 LBS. (180 KGS), TRUCK, FREIGHT CLASS 150, 24 HOUR SHIP

BACKBOARD: 32" x 54" acrylic backboard (Model: GP5432)

GOAL: 724 breakaway goal.

PADDING: Fully padded with high density polyurethane foam covered with non-tearing 14 oz. black vinyl. *Optional LSCE backboard padding not included.*

BALLAST: 250 lbs. (114 Kgs.) of ballast required and concealed in the base of the unit. Provided by customer.

HEIGHT ADJUSTABLE: Spring assisted unit adjusts from 7' juniors' to 10' regulation heights.



The **MINI-EZ™** is designed to provide rugged durability for home, club or church use • This highly portable system rolls easily on four large casters and sets in place with the flip of a lever • It features heavy duty steel construction and direct mount goal design • It folds down to 48" W x 80 1/2" H x 62" L -including board & goal • This portable is not recommended for main court use or dunking activities • **PLEASE NOTE: OUTDOOR USE AND STORAGE OF THE MINI-EZ VOIDS WARRANTY.**

MINI-EZ™: ROLL-AROUND BASKETBALL BACKSTOP

2 YEAR LIMITED WARRANTY, WEIGHT: 290 LBS. (148 KGS), TRUCK, FREIGHT CLASS 150, 24 HOUR SHIP

BACKBOARD: GP4832 ISQ 48" x 32" rectangular acrylic backboard with 3/8" thickness affixed to a superior 1" welded aluminum uni-frame.

GOAL: 26VO standard stationary goal with nylon net.

PADDING: Fully padded with high density polyurethane foam covered with non-tearing 18 oz. black vinyl. *Optional LSCE backboard padding not included.*

BALLAST: 250 lbs. (114 Kgs.) of ballast required and concealed in the base of the unit. Provided by customer.

HEIGHT ADJUSTABLE: Spring assisted unit adjusts from 7' juniors' to 10' regulation heights.



GARED has all the equipment you need for one of the fastest growing sports worldwide – NETBALL! • We carry a large assortment of Netball Systems, whether you're playing in an official league, or just want an economical system for your backyard • Choose from our steel or aluminum systems, with either portability or inground mounting to fit your specific needs • Netball systems include an orange powdercoated rim with 15" diameter for official play, along with post, net, and hardware • Portable systems include a base for easy transport of unit • Some systems not shown in catalog - visit WWW.GAREDSPORTS.COM for our complete selection of premium **HOOPLA™ NETBALL EQUIPMENT.**

8415: RECREATIONAL PORTABLE HOOPLA™ NETBALL SYSTEM

1 YEAR WARRANTY, WEIGHT: 28 LBS, GROUND COURIER SERVICE, 24 HOUR SHIP

- Telescopic post allows rim to easily adjust to 8 ft, 9 ft, and 10 ft heights
- Post is 2" O.D., 10' tall
- Post is constructed of steel and powdercoated white for maximum protection and longer life
- Plastic base measures 33 1/2" x 22" x 6 1/2"
- Base can be filled with water or sand (not included) for stability of unit
- System includes wheels on the base for easy mobility
- Complete system includes (1) base, (1) post, (1) rim and (1) net
- Designed for home and recreational use



ARE YOU BUILDING A BASKETBALL COURT, BUT UNSURE WHERE TO BEGIN?

When searching for an outdoor system, consider play environment, usage, weather elements, and budgetary concerns. GARED makes it easy by offering three levels of outdoor posts and packages – economy, standard-duty, and heavy-duty – so you can choose the outdoor system that is most suitable for your application.

OUTDOOR POSTS

Build your court by first choosing an appropriate backstop - **GARED OUTDOOR POSTS** are offered in several styles, sizes and safe play zones to fit your facility's needs • Posts are formed from heavy wall galvanized steel for superior protection against weather elements • Each post is approximately 13' tall, with 3' to be installed in a 4' x 2' concrete footing to ensure long-lasting post stability • 5-9/16" and 6-5/8" O.D. posts are comprised of Schedule 40 steel, providing unmatched strength and durability to the units • All posts contain a backboard mounting plate welded to post end for hassle-free attachment to most backboards • Powdercoated posts available – please call for quotation • PPWR post padding is optional and recommended.

GN/GNA SERIES: GOOSENECK POSTS

SEE CHART FOR WEIGHTS, TRUCK, FREIGHT CLASS 50, 24 HOUR SHIP

- Round post with traditional gooseneck design
- Fixed height
- Available with or without backboard braces
- Braced units include a V-brace with attachment hardware to eliminate backboard vibration

GN/GNA SERIES: GOOSENECK POSTS

MODEL #	DESCRIPTION	POST O.D.	EXT	ADJUST-ABLE?	MOUNTING TYPE	WT	LTD. WARRANTY
GNA35	Unbraced Gooseneck	3 1/2"	3'	No	Front Mount	72	10 Year
GNA35R	Unbraced Gooseneck	3 1/2"	3'	No	Rear-Mount	72	10 Year
GN35	Braced Gooseneck	3 1/2"	3'	No	Front Mount	78	10 Year
GN35R	Braced Gooseneck	3 1/2"	3'	No	Rear-Mount	78	10 Year
GNA45	Unbraced Gooseneck	4 1/2"	4'	No	Front Mount	128	25 Year
GNA45R	Unbraced Gooseneck	4 1/2"	4'	No	Rear-Mount	128	25 Year
GN45	Braced Gooseneck	4 1/2"	4'	No	Front Mount	134	25 Year
GN45R	Braced Gooseneck	4 1/2"	4'	No	Rear-Mount	134	25 Year
GN455	Braced Gooseneck	4 1/2"	5'	No	Front Mount	146	25 Year
GN455R	Braced Gooseneck	4 1/2"	5'	No	Rear-Mount	146	25 Year
GN60	Braced Gooseneck	5 9/16"	6'	No	Front Mount	259	Lifetime

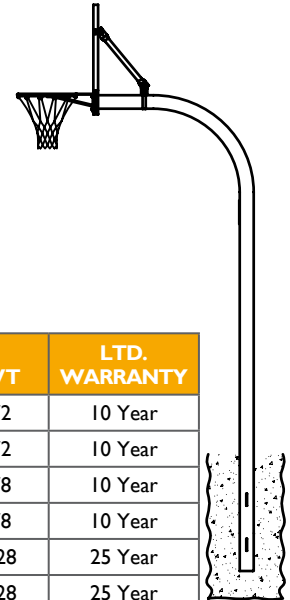

AAB/AABS SERIES: ADJUSTABLE STRAIGHT POSTS

SEE CHART FOR WEIGHTS, TRUCK, FREIGHT CLASS 50, 24 HOUR SHIP

- Straight vertical round post with horizontal extension arm
- Arm is height-adjustable to allow for all-age play settings
- All units include a V-brace with attachment hardware to eliminate backboard vibration
- 5-9/16" and 6-5/8" posts include an additional strut connecting the vertical post to the arm for added rigidity

AAB/AABS SERIES: ADJUSTABLE STRAIGHT POSTS

MODEL #	DESCRIPTION	POST O.D.	EXT	ADJUST-ABLE?	MOUNTING TYPE	WT	LTD. WARRANTY
AAB35	Straight Post w/ Braced Arm	3 1/2"	3'	Yes	Front Mount	91	10 Year
AAB35R	Straight Post w/ Braced Arm	3 1/2"	3'	Yes	Rear-Mount	91	10 Year
AAB45	Straight Post w/ Braced Arm	4 1/2"	4'	Yes	Front Mount	138	25 Year
AAB45R	Straight Post w/ Braced Arm	4 1/2"	4'	Yes	Rear-Mount	138	25 Year
AABS60	Straight Post w/ Braced & Strutted Arm	5 9/16"	5'	Yes	Front Mount	287	Lifetime
AABS65	Straight Post w/ Braced & Strutted Arm	6 5/8"	6'	Yes	Front Mount	362	Lifetime
DP35	Double Straight Post w/ Two Arms	3 1/2"	Two 3'	No	Front Mount	220	10 Year

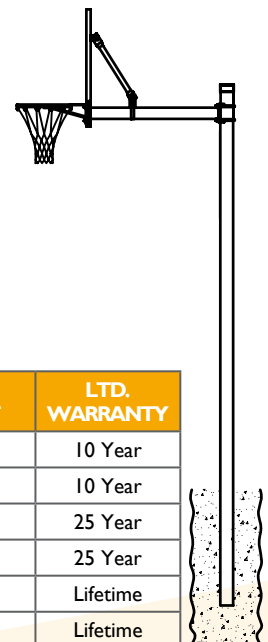



PK3515 FRONT VIEW



PK3515 BACK VIEW



PK3545 BACK VIEW WITH BRACES

REAR-MOUNT PRODUCT ORDERING TIP

Please remember, when choosing GARED'S Rear-Mount configuration: Post - Model # ends with "R" Backboard - Model # contains "66" Rim - Model # contains "66"

Looking for a budget-friendly outdoor system that stands the test of time? **GARED ECONOMY OUTDOOR GOOSENECK** and **STRAIGHT POST PACKAGES** are the perfect choice for lightly-used facilities such as elementary schools, daycares, rural parks, and residences. Paired up with your favorite GARED fan backboard and institutional single rim, these light-duty packages make it easy to outfit your court without breaking your budget.

ECONOMY OUTDOOR GOOSENECK PACKAGES

MODEL#	GOOSENECK	BACKBOARD	GOAL	WT
PK3505	GNA35 – Unbraced 3 1/2" O.D. w/ 3' ext	I701 – Fan-Shape Aluminum, Natural	39WO – Fixed Single Rim	134
PK3510	GNA35 – Unbraced 3 1/2" O.D. w/ 3' ext	I750 – Fan-Shape Aluminum, White	39WO – Fixed Single Rim	134
PK3515	GNA35R – Unbraced 3 1/2" O.D. w/ 3' ext	I266 – Fan-Shape Steel, White, Rear-Mount	66T – Fixed Single Rim, Rear-Mount	173
PK3530	GN35 – Braced 3 1/2" O.D. w/ 3' ext	BB48A38 - 36" x 48" Rectangular Acrylic	726 – Breakaway Single Rim	176
PK3535	GN35 – Braced 3 1/2" O.D. w/ 3' ext	I750B - Fan-Shape Aluminum W/ Target & Border	39WO – Fixed Single Rim	140
PK3540	GN35 – Braced 3 1/2" O.D. w/ 3' ext	I245T – Fan-Shape Steel W/ Target	39WO – Fixed Single Rim	174
PK3545	GN35R – Braced 3 1/2" O.D. w/ 3' ext	I266 – Fan-Shape Steel, White, Rear-Mount	66T – Fixed Single Rim, Rear-Mount	179

ECONOMY OUTDOOR STRAIGHT POST PACKAGES

MODEL#	STRAIGHT POST	BACKBOARD	GOAL	WT
PK3511	AAB35 - 3 1/2" O.D. w/ 3' ext	I750 – Fan-shape Aluminum	39WO – Fixed Single Rim	153
PK3531	AAB35 - 3 1/2" O.D. w/ 3' ext	BB48A38 – 36" x 48" Acrylic	726 – Breakaway Single Rim	189



PK4551



PK4540

PK4560



STANDARD-DUTY OUTDOOR PACKAGES

A common size shouldn't necessarily imply common quality. Although **GARED STANDARD-DUTY OUTDOOR SYSTEMS** are comprised of a park industry standard 4-1/2" O.D. post, these systems are legendary for their uncompromising strength and stability. You'll be in good company when you choose a Standard-Duty Package with a conventional fan or rectangular backboard and traditional double rim goal. Parks, schools, camps, and recreational facilities that demand premium systems at competitive prices know that GARED is always ahead of the game.

STANDARD-DUTY OUTDOOR GOOSENECK PACKAGES

MODEL#	GOOSENECK	BACKBOARD	GOAL	WT
PK4530	GN45 - 4 1/2" O.D. w/ 4' ext	BB60A38 - 42" x 60" Acrylic	726 - Breakaway Single Rim	244
PK4540	GN45 - 4 1/2" O.D. w/ 4' ext	I245T - Fan-shape Steel w/ Target	240 - Fixed Double Rim	235
PK4570	GN45R - 4 1/2" O.D. w/ 4' ext	I266B - Fan-shape Steel, White, Rear-Mount	266 - Fixed Double Rim, Rear-Mount	237
PK4560	GN45 - 4 1/2" O.D. w/ 4' ext	I260B - 42" x 60" Steel w/ Target & Border	240 - Fixed Double Rim	264
PK4565	GN45 - 4 1/2" O.D. w/ 4' ext	I750B - Fan-shape Aluminum w/ Target & Border	240 - Fixed Double Rim	201

STANDARD-DUTY OUTDOOR STRAIGHT POST PACKAGES

MODEL#	STRAIGHT POST	BACKBOARD	GOAL	WT
PK4541	AAB45 - 4 1/2" O.D. w/ 4' ext	I750B - Fan-shape Aluminum w/ Target & Border	240 - Fixed Double Rim	205
PK4551	AAB45 - 4 1/2" O.D. w/ 4' ext	I260B - 42" x 60" Steel w/ Target & Border	240 - Fixed Double Rim	268
PK4531	AAB45 - 4 1/2" O.D. w/ 4' ext	I245T - Fan-shape Steel w/ Target	240 - Fixed Double Rim	268



HEAVY-DUTY OUTDOOR PACKAGES

Extreme play can be hard on typical outdoor basketball systems. Only GARED delivers a **HEAVY-DUTY OUTDOOR SYSTEM** that can easily bear the brunt of today's strong and aggressive players, while the Schedule 40 galvanized steel posts provide an unyielding backstop in harsh play environments. Whether your court is in a busy park, school playground, urban area, or military base, you can count on GARED Heavy-Duty Systems to take on the roughest games and keep coming back for more.

HEAVY-DUTY OUTDOOR GOOSENECK PACKAGES

MODEL.#	GOOSENECK	BACKBOARD	GOAL	WT
PK6005	GN60 - 5 9/16" O.D. w/ 6' ext	I272B - 42" x 72" Steel w/ Target & Border	7550 - Titan Fixed Double Rim	413
PK6015	GN60 - 5 9/16" O.D. w/ 6' ext	I260B - 42" x 60" Steel w/ Target & Border	7550 - Titan Fixed Double Rim	394
PK6025	GN60 - 5 9/16" O.D. w/ 6' ext	BB60G38 - 42" x 60" Glass	5500 - Breakaway Double Rim	481
PK6040	GN60 - 5 9/16" O.D. w/ 6' ext	BB72A38 - 42" x 72" Acrylic	5500 - Breakaway Double Rim	397

HEAVY-DUTY OUTDOOR STRAIGHT POST PACKAGES

MODEL.#	STRAIGHT POST	BACKBOARD	GOAL	WT
PK6051	AABS60 - 5 9/16" O.D. w/ 5' ext	I272B - 42" x 72" Steel w/ Target & Border	7550 - Titan Fixed Double Rim	441
PK6091	AABS60 - 5 9/16" O.D. w/ 5' ext	BB72G50 - 42" x 72" Glass	5500 - Breakaway Double Rim	509
PK6010	AABS65 - 6 5/8" O.D. w/ 6' ext	I272B - 42" x 72" Steel w/ Target & Border	7550 - Titan Fixed Double Rim	516



GARED knows that hard-hitting players demand outdoor equipment that can keep up with their strength and stamina • After months of rigorous testing by our team of engineers, **GARED'S ENDURANCE® PLAYGROUND BASKETBALL SYSTEMS** were developed specifically for such players • The units were tested for post deflection, backboard vibration, structural integrity, and load capacity, and easily passed with flying color • GARED's Endurance® Systems are far and away the strongest and most uncompromising outdoor basketball systems available today • Why trust your park or playground to anything less?



GP100 SERIES: ENDURANCE® PLAYGROUND BASKETBALL SYSTEM PACKAGES

SEE CHARTS FOR WEIGHTS, TRUCK, CLASS 70, 24 HOUR SHIP

- 6" x 6" square steel inground post, approximately 14' tall, with 42" installed in concrete footing
- Post is 1/4" thick schedule 40 steel, where other manufacturers only offer a 3/16" post
- Exclusive heavy-gauge triangular extension arm and thick bracing for board stability
- Protected by Enduracoat™ technology where post, extension arm, and braces are galvanized first, then powdercoated black for longer life
- Steel board systems include fixed Endurance® rim
- Glass and acrylic board systems include breakaway Endurance® rim
- Choose backboard type, backboard size, and safe play area to customize system based on needs
- Post and backboard padding are optional and recommended for safer play
- Limited Lifetime Warranty on post, arm, and bracing components
- 7' extension option available with all package configurations



GP105G72
OPTIONAL POLE PAD SHOWN

MODEL #	POST	EXT	BACKBOARD	GOAL	WT
STEEL BACKBOARD SYSTEMS					
GP105S72	6" Square	5'	1272B – 72" Steel	8550 – Endurance Fixed	509
GP105S60	6" Square	5'	1260B – 60" Steel	8550 – Endurance Fixed	490
GP106S72	6" Square	6'	1272B – 72" Steel	8550 – Endurance Fixed	519
GP106S60	6" Square	6'	1260B – 60" Steel	8550 – Endurance Fixed	500
GLASS BACKBOARD SYSTEMS					
GP104G72	6" Square	4'	BB72G50 – 72" Glass	8800 – Endurance Breakaway	552
GP104G60	6" Square	4'	BB60G38 – 60" Glass	8800 – Endurance Breakaway	500
GP105G72	6" Square	5'	BB72G50 – 72" Glass	8800 – Endurance Breakaway	562
GP105G60	6" Square	5'	BB60G38 – 60" Glass	8800 – Endurance Breakaway	510
GP106G72	6" Square	6'	BB72G50 – 72" Glass	8800 – Endurance Breakaway	572
GP106G60	6" Square	6'	BB60G38 – 60" Glass	8800 – Endurance Breakaway	520
ACRYLIC BACKBOARD SYSTEMS					
GP104A72	6" Square	4'	BB72A38 – 72" Acrylic	8800 – Endurance Breakaway	499
GP104A60	6" Square	4'	BB60A38 – 60" Acrylic	8800 – Endurance Breakaway	447
GP105A72	6" Square	5'	BB72A38 – 72" Acrylic	8800 – Endurance Breakaway	509
GP105A60	6" Square	5'	BB60A38 – 60" Acrylic	8800 – Endurance Breakaway	457
GP106A72	6" Square	6'	BB72A38 – 72" Acrylic	8800 – Endurance Breakaway	519
GP106A60	6" Square	6'	BB60A38 – 60" Acrylic	8800 – Endurance Breakaway	467
DOUBLE BOARD SYSTEMS					
GP205S60	6" Square	5'	Two 1260B – 60" Steel	8550 – Endurance Fixed	629
GP205G60	6" Square	5'	Two BB60G38 – 60" Glass	8800 – Endurance Breakaway	683

GARED'S ENDURANCE® POST IS GALVANIZED THEN POWDERCOATED FOR A LONGER PLAYGROUND LIFE!

7 FOOT EXTENSIONS AVAILABLE UPON REQUEST

GARED PRO SERIES

Play like the pros with the complete line of **GARED PRO SERIES ADJUSTABLE BASKETBALL SYSTEMS!** • Height adjustment actuator mechanism allows rim height to easily adjust from 7' to regulation 10' • Large actuator with 90° handle makes it easy for all ages to raise and lower the system • Square heavy-gauge steel post with 3/16" wall thickness provides superior strength and durability • Bolt-to-ground post design allows for no-hassle installation and portability of unit • Post is powdercoated black for protection against harsh weather elements • Heavy tubular lower arm provides a direct-goal attachment for backboard and rim • Backboard braces extend to the outer corners of the backboard, allowing for a clear, unobstructed view during play • Backboard is comprised of glass with direct mount attachment to a heavy steel welded uni-frame for extra support and safer play • Board features a white target and border and square corners for a professional, arena-style look • Heavy-duty breakaway goal with nylon net stands up to any level of competitive play • Premium board and pole padding are optional.



VARISTY JAM
GP7G60



COLLEGIATE JAM
GP8G60DM



PRO JAM
GP10G72DM



ALL PRO JAM
GP12G72DM

MODEL #	GARED PRODUCT NAME	GROUND MOUNTING	POST	BACKBOARD	RIM	PADS INCLUDED	WT LBS
GP7G54	Varsity Jam	Surface Mount	5" Square Post w/ 2.5' ext	BB54G38 - 34" x 54" ClearView™ Glass	Titan Breakaway	N	392
GP7G60	Varsity Jam	Surface Mount	5" Square Post w/ 2.5' ext	BB60G38HH - 36" x 60" ClearView™ Glass	Titan Breakaway	N	406
GP8A60DM	Collegiate Jam	Surface Mount	5" Square Post w/ 3' ext	BB60A38 - 42" x 60" Acrylic	1000 - Scholastic Breakaway	N	409
GP8G60DM	Collegiate Jam	Surface Mount	5" Square Post w/ 3' ext	BB60G38HH - 42" x 60" ClearView™ Glass	1000 - Scholastic Breakaway	N	456
GP10A72DM	Pro Jam	Surface Mount	6" Square Post w/ 4' ext	BB72A38 - 42" x 72" Acrylic	2000+ - Collegiate Breakaway	N	475
GP10G72DM	Pro Jam	Surface Mount	6" Square Post w/ 4' ext	BB72G50HH - 42" x 72" ClearView™ Glass	2000+ - Collegiate Breakaway	N	549
GP10P72DM	Pro Jam	Surface Mount	6" Square Post w/ 4' ext	BB72P50 - 42" x 72" Polycarbonate	2000+ - Collegiate Breakaway	N	486
GP12A72DM	All Pro Jam	Surface Mount	6" x 8" Square Post w/ 4' ext	BB72A38 - 42" x 72" Acrylic	2000+ - Collegiate Breakaway	N	514
GP12G72DM	All Pro Jam	Surface Mount	6" x 8" Square Post w/ 4' ext	BB72G50HH - 42" x 72" ClearView™ Glass	2000+ - Collegiate Breakaway	N	589
GP12P72DM	All Pro Jam	Surface Mount	6" x 8" Square Post w/ 4' ext	BB72P50 - 42" x 72" Polycarbonate	2000+ - Collegiate Breakaway	N	525



Use your basketball court for several different sports with our innovative new **OUTDOOR SIDE-FOLD BASKETBALL SYSTEM!** • This system is a great option for budget-conscious facilities and multi-use courts, as the extension arms and backboard conveniently fold to the side and out of the way of other court activities • Heavy-duty 5-9/16" O.D. galvanized steel vertical posts are designed to be mounted permanently inground into a concrete footing for optimal stability • A third vertical post is included to securely attach backboard and prevent movement while it is folded in the storage position • 2" square galvanized steel horizontal extension arms attach posts to backboard with four-corner mounting • Extension arms are 15' in length, providing the largest available safe play area on the market today • System includes a regulation 42" x 72" fiberglass backboard with black target and border, and single fixed rim with nylon net.

BSF46: OUTDOOR SIDE-FOLD BASKETBALL SYSTEM

WEIGHT: 1200 LBS, TRUCK, FREIGHT CLASS 70, 24-HOUR SHIP



Play both Netball and Basketball on a single versatile unit with our new **HOOPLA™ COMBO NETBALL /BASKETBALL SYSTEM!** • Single 5-9/16" O.D. galvanized steel post provides strength and durability for any playground or park setting • Post measures 12' 6" tall from ground level to top of post, and includes ground sleeve for convenient removal of post for multi-use courts or seasonal use • Netball side of unit includes 15" diameter orange powdercoated rim with nylon net • Basketball side of unit has 4-1/2" O.D. horizontal extension arm with massive 8' safe play area from post to backboard • 3-1/2" O.D. brace underneath extension arm provides unyielding support during heavy play • Includes regulation size 42" x 72" fiberglass backboard with black target and border, and Endurance heavy-duty fixed double rim with nylon net.

BNB24P: OUTDOOR HOOPLA COMBO BASKETBALL SYSTEM

WEIGHT: 475 LBS, TRUCK, FREIGHT CLASS 70, 24 HOUR SHIP



FIBERGLASS BACKBOARDS

Looking for superior rebounds on a non-glass surface? **GARED'S RECTANGULAR FIBERGLASS BACKBOARD** is the answer for indoor/outdoor play • Features molded fiberglass for strength & superior rebounding surface • Screen printed target and border • Fan-shape and rectangular backboard molded inserts are positioned at 20" vertically by 35" horizontal centers for mounting • Compatible Mounting: Ceiling & Wall Mounted systems, Gooseneck & Straight-Arm Posts • Recommended Rims: 8550, 5500, 8800, 7550, 240, 39WO • For indoor or outdoor use.

I342B-BLK: 42" X 72" RECTANGULAR FIBERGLASS BACKBOARD WITH BLACK TARGET AND BORDER

10 YEAR INDOOR/5 YEAR OUTDOOR LIMITED WARRANTY, 5" X 5" TO 5" X 4 1/2" HOLE SPACING, WEIGHT: 86 LBS, TRUCK, FREIGHT CLASS 70, 24 HOUR SHIP



The **GARED UNIVERSAL ADAPTER PLATE** protects your basketball rim from unauthorized use or theft by allowing easy removal from your board when not in use • Goal slides tightly into adapter plate for securement while playing and slides out when game is finished • Made of heavy-gauge with welded flange for superior durability • Plate's universal hole pattern will bolt to most backboards • Will work with most front-mount fixed goals with 5" to 7" back-plates.

GSUAP: UNIVERSAL ADAPTER PLATE

1 YEAR LIMITED WARRANTY, WEIGHT: 9 LBS, GROUND COURIER SERVICE, 24 HOUR SHIP



HEAVY-GUAGE STEEL CHAIN NET is designed for use with outdoor rims • Popular choice for playground and park settings, as it will not stretch, tangle, break, or shrink during heavy play • Available for use with single-rim and double-rim goals.

CN: STEEL CHAIN NET FOR RIMS WITH NO-TIE NET ATTACHMENT

WEIGHT: 1 LB, GROUND COURIER SERVICE, 24 HOUR SHIP

SCN: STEEL CHAIN NET FOR RIMS WITH BUMPED DOUBLE RINGS

WEIGHT: 1 LB, GROUND COURIER SERVICE, 24 HOUR SHIP

WCN: WELDED CHAIN NET, WEIGHT: 4 LB, GROUND COURIER SERVICE, 24 HOUR SHIP

NYLON WEB NET is ideal for outdoor use • Great alternative to chain and standard nylon nets • Will not rot, rust, or decay • Includes heavy "S" hooks for attaching to rim.

WN: WEB NET, WEIGHT: 3 LBS, GROUND COURIER SERVICE, 24 HOUR SHIP

OUTDOOR PADDING

RECREATIONAL PRO-MOLD BACKBOARD PADDING provides backboard protection to decrease risk of player head injury • Durable polyurethane foam is designed for long life in heavy play environments and resistance to weather elements • Bolts to metal framing using self-tapping screws on outdoor rectangular glass and acrylic backboards • Available for 48", 54", 60", and 72" backboards • Available in black only • **All pads are offered with 1 year limited warranty.**

LSCE48: 48" RECREATIONAL PRO-MOLD RECREATIONAL BACKBOARD PADDING

WEIGHT: 7 LBS, GROUND COURIER SERVICE, 24 HOUR SHIP

LSCE54: 54" RECREATIONAL PRO-MOLD RECREATIONAL BACKBOARD PADDING

WEIGHT: 7 LBS, GROUND COURIER SERVICE, 24 HOUR SHIP

LSCE60: 60" RECREATIONAL PRO-MOLD RECREATIONAL BACKBOARD PADDING

WEIGHT: 8 LBS, GROUND COURIER SERVICE, 24 HOUR SHIP

LSCE72: 72" RECREATIONAL PRO-MOLD RECREATIONAL BACKBOARD PADDING, WEIGHT: 9 LBS, GROUND COURIER SERVICE, 24 HOUR SHIP



WRAP-AROUND POLE PADS protect players from injury due to contact with basketball, volleyball, tetherball, or other game poles • Made of 2" foam covered in UV-resistant vinyl for maximum protection and long life • Wraps around pole with Velcro® strips in back for closure • For use on both square and round poles • Available in black only.



PP4WR: WRAP-AROUND POLE PAD

WEIGHT: 4 LBS, GROUND COURIER SERVICE, 24 HOUR SHIP

For use with these pole sizes: 3-1/2" O.D. round poles • 4 to 4-1/2" O.D. round poles • 4" square poles.

PP6WR: WRAP-AROUND POLE PAD

WEIGHT: 7 LBS, GROUND COURIER SERVICE, 24 HOUR SHIP

For use with these pole sizes: 4-1/2" to 6" O.D. round poles • 5" square poles • 6" square poles,

PP8WR: WRAP-AROUND POLE PAD

WEIGHT: 8 LBS, GROUND COURIER SERVICE, 24 HOUR SHIP

For use with these pole sizes: 6-5/8" O.D. round poles • 8" O.D. round poles • 8" square poles.



FITTED POLE PADS protect players from contact with posts and fit securely without spinning • Made of 1" foam covered in UV-resistant vinyl for superior protection and long life • Features mitered corners to fit snugly and Velcro® strips in back for closure • For use with square posts only • Available in black only.



PP4SQF: FITTED POLE PAD FOR 4" SQUARE POSTS

WEIGHT: 4 LBS, GROUND COURIER SERVICE, 24 HOUR SHIP

PP5SQF: FITTED POLE PAD FOR 5" SQUARE POSTS

WEIGHT: 5 LBS, GROUND COURIER SERVICE, 24 HOUR SHIP

PP6SQF: FITTED POLE PAD FOR 6" SQUARE POSTS

WEIGHT: 7 LBS, GROUND COURIER SERVICE, 24 HOUR SHIP

PP8SQF: FITTED POLE PAD FOR 8" SQUARE POSTS

WEIGHT: 9 LBS, GROUND COURIER SERVICE, 24 HOUR SHIP

BASE POLE PADS cover mounting and base hardware on surface-mounted basketball systems to prevent player injury • Made of 2" foam covered in UV-resistant vinyl for maximum protection and long life in outdoor settings • Wraps around base of pole with Velcro® strip for closure • For use on square poles only • Available in black only.

BP4SQ: BASE POLE PAD FOR 4" SQUARE POSTS

WEIGHT: 1 LB, GROUND COURIER SERVICE, 24 HOUR SHIP

BP5SQ: BASE POLE PAD FOR 5" SQUARE POSTS

WEIGHT: 1 LB, GROUND COURIER SERVICE, 24 HOUR SHIP

BP6SQ: BASE POLE PAD FOR 6" SQUARE POSTS

WEIGHT: 1 LB, GROUND COURIER SERVICE, 24 HOUR SHIP

BP8SQ: BASE POLE PAD FOR 8" SQUARE POSTS

WEIGHT: 1 LB, GROUND COURIER SERVICE, 24 HOUR SHIP





BASKETBALL EQUIPMENT

At GARED, we love basketball! No one knows basketball better than us. For almost a century, our dedication to the sport keeps us constantly innovating and improving our equipment - for the safety of the players, and to better the game itself. It's no surprise that we have the most comprehensive selection of basketball equipment and accessories in the industry – for every budget, skill level, and play setting! With GARED being the undisputed leader in the design and manufacturer of elite basketball products for over 90 years, you can trust that our basketball backboards, rims, padding, and training aids are the strongest and most dependable on the market today. See why thousands of satisfied customers have chosen GARED for all of their basketball needs since 1922!

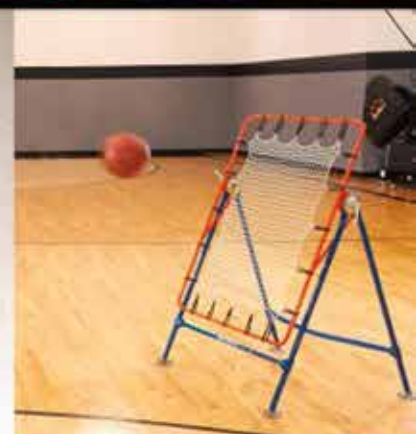

When choosing the right **GLASS BACKBOARD** for your facility, choose GARED • Our line features the most comprehensive options for every play environment • Not all glass backboards are created equally, which is why all indoor GARED glass backboards feature 1/2" tempered glass, fired-in target and border and 'Made in the USA' stamp of approval • Regardless of size, shape, frame type, or application - we can ensure that you will be creating premium level of play • When pairing glass backboards and rims, GARED recommends that you choose one of our universally compatible breakaway rims to protect the life of your backboard.

STEEL FRAMED GLASS BACKBOARDS

Why is Steel different from Aluminum? Steel's inherent qualities of strength and durability create the ultimate support structure for the tempered glass • While most aluminum framed boards fail at about 700 lbs of pressure - **GARED STEEL FRAMED REGULATION BACKBOARDS** can withstand in excess of 1100 lbs of direct force • Additionally, the steel frames are powdercoated to prevent oxidation and increase the board's longevity • Our steel framed line includes regulation 42" x 72", tall 48" x 72", and a conversion 42" x 72" • All backboards meet NCAA, NAIA & NFHS specifications • **GARED'S LIMITED LIFETIME & 10 YEAR WARRANTIES** cover all steel-framed glass backboards.

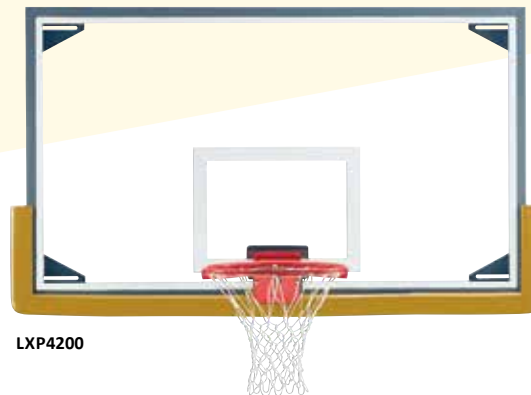

LXP4200



ARG

LXP4200: 42" X 72" REGULATION STEEL FRAMED GLASS BACKBOARD
LIMITED LIFETIME WARRANTY, 4" X 5" HOLE SPACING,
WEIGHT: 201 LBS. (92 KGS.) TRUCK, FREIGHT CLASS 85, 24 HOUR SHIP

LXP4200LED: 42" X 72" REGULATION STEEL FRAMED GLASS BACKBOARD
LIMITED LIFETIME WARRANTY, SAME AS LXP4200 WITH OUR PERIMETER LED LIGHT SYSTEM, LIMITED LIFETIME WARRANTY ON GLASS BACKBOARD ONLY,
4" X 5" HOLE SPACING, WEIGHT: 224 LBS. (99 KGS.) TRUCK, FREIGHT CLASS 85, 24 HOUR SHIP

RG: 48" X 72" TALL STEEL FRAMED GLASS BACKBOARD
LIMITED LIFETIME WARRANTY, 5" X 5" HOLE SPACING,
WEIGHT: 218 LBS. (99 KGS.) TRUCK, FREIGHT CLASS 85, 24 HOUR SHIP

ARG: 42" X 72" CONVERSION STEEL FRAMED BACKBOARD
LIMITED LIFETIME WARRANTY, 4" X 5" HOLE SPACING,
WEIGHT: 220 LBS. (100 KGS.) TRUCK, FREIGHT CLASS 85, 24 HOUR SHIP

ALUMINUM FRAMED GLASS BACKBOARDS

Exceeding our competitor's aluminum framed board 650 lb pressure breaking point - **GARED'S ALUMINUM FRAMED BACKBOARD SERIES** is the strongest in the industry and relieves the worries of rusting • In addition, GARED'S elite aluminum OuterLimit Pro backboards have never broken - even under the pressure of two decades of play in NBA arenas • Our aluminum framed line includes regulation and pro level 42" x 72" and 48" x 72" backboards • All backboards meet NCAA, NAIA & NFHS specifications • **GARED'S LIMITED LIFETIME & 10 YEAR WARRANTIES** cover all aluminum-framed glass backboards.



AFRG42

AFRG42: 42" X 72" REGULATION ALUMINUM FRAMED GLASS BACKBOARD
LIMITED LIFETIME WARRANTY, 4" X 5" HOLE SPACING,
WEIGHT: 184 LBS. (84 KGS.) TRUCK, FREIGHT CLASS 85, 24 HOUR SHIP

AFRG42E: 42" X 72" REGULATION ECONOMY ALUMINUM FRAMED GLASS BACKBOARD
10 YEAR LIMITED WARRANTY, 4" X 5" HOLE SPACING,
WEIGHT: 184 LBS. (84 KGS.) TRUCK, FREIGHT CLASS 85, 24 HOUR SHIP

AFRG42LED: 42" X 72" REGULATION ALUMINUM FRAMED GLASS BACKBOARD
LIMITED LIFETIME WARRANTY, 4" X 5" HOLE SPACING,
WEIGHT: 190 LBS. (91 KGS.) TRUCK, FREIGHT CLASS 85, 24 HOUR SHIP

AFRG48: 48" X 72" REGULATION ALUMINUM FRAMED GLASS BACKBOARD
LIMITED LIFETIME WARRANTY, 5" X 5" HOLE SPACING,
WEIGHT: 203 LBS. (93 KGS.) TRUCK, FREIGHT CLASS 85, 24 HOUR SHIP

2137: BUZZER BEATER™ PERIMETER LED LIGHT KIT

The **GARED BUZZER BEATER™ PERIMETER LED LIGHT STRIPS**, neatly housed inside custom PVC extrusions, are cleanly interconnected to eliminate the clutter usually found in competitors' systems • Affixed to the outermost part of the back of the glass backboard, the LED lights are easily seen without blocking the view from behind the glass or interfering with play • They comply with the most recent recommendations from FIBA, NCCA and NBA • The kit includes LED light strips, adapter cable and 120 or 220 Volt AC power supply with 24 Volt AC output • The lights are turned on and off from a signal sent from the shot clock and scoreboard • Please specify shot clock and score board manufacturer and model number • Purchase new board with the perimeter LED lights factory installed – **LXP4200LED & AFRG42LED**. Please mention shot clock model and scoreboard manufacturer number when ordering **PERIMETER BUZZER BEATER™ LED LIGHT KIT**.

2137: PERIMETER BUZZER BEATER™ LED LIGHT KIT

1 YEAR LIMITED WARRANTY, WEIGHT: 14 LBS. (7 KGS.)
GROUND COURIER SERVICE, 24 HOUR SHIP



2137 INSTALLED



LED INTENSITY



2137 KIT

GYMNASIUM BACKBOARD EASY BUY PACKAGES

Are you trying to match your level of play with the right equipment? GARED has put together the top selling **INDOOR GYMNASIUM PACKAGES** configurations to make the right choice an easy one. All configurations meet NCAA, NAIA & NFHS specifications.

PKAFR40PMLED: BUZZER BEATER™ GYMNASIUM PACKAGE

WEIGHT: 220 LBS. (100 KGS.) TRUCK, FREIGHT CLASS 85, 24 HOUR SHIP

- Ideal for regulation play with highly skilled players
- Buzzer Beater™ perimeter lighting system
- AFRG42: 42" x 72" regulation aluminum framed glass backboard
- 4000+ multi-directional rim
- PMCE: Bolt-on PRO-MOLD® backboard padding



PKAFR40PMLED



PKAFR30PM

PKAFR30PM: MASTER GYMNASIUM PACKAGE

WEIGHT: 220 LBS. (100 KGS.) TRUCK, FREIGHT CLASS 85, 24 HOUR SHIP

- Ideal for regulation play with highly skilled players
- AFRG42: 42" x 72" regulation aluminum framed glass backboard
- Master 3000® breakaway rim
- PMCE: Bolt-on PRO-MOLD® backboard padding

**PKLXP20PM : COLLEGIATE GYMNASIUM PACKAGE**

WEIGHT: 236 LBS. (108 KGS.) TRUCK, FREIGHT CLASS 85, 24 HOUR SHIP

- Ideal for heavy duty, unsupervised play
- LXP4200: 42" x 72" regulation steel-framed glass backboard
- Collegiate 2000+ breakaway rim
- PMCE: Bolt-on PRO-MOLD® backboard padding



PKLXP20M



PKRG20PM

PKRG20PM: SCHOLASTIC GYMNASIUM PACKAGE

WEIGHT: 236 LBS. (115 KGS.) TRUCK, FREIGHT CLASS 85, 24 HOUR SHIP

- Traditional tall board package
- Ideal for heavy duty, unsupervised play
- RG: 48" x 72" steel-framed glass backboard
- Collegiate 2000+ breakaway rim
- PMCE: Bolt-on PRO-MOLD® backboard padding

**PKLXP10PS : BUDGET GYMNASIUM PACKAGE**

WEIGHT: 236 LBS. (108 KGS.) TRUCK, FREIGHT CLASS 85, 24 HOUR SHIP

- Ideal for heavy duty, unsupervised play
- LXP4200E: 42" x 72" regulation steel-framed glass backboard
- Scholastic 1000 flex breakaway rim
- CE: Grey stick-on backboard padding



PKLXP10PS



PK305010PM

PK305010PM: CONVERSION GYMNASIUM PACKAGE

WEIGHT: 205 LBS. (94 KGS.) TRUCK, FREIGHT CLASS 85, 24 HOUR SHIP

- Ideal for side-court play
- 3050RG: 42" x 54" auxiliary glass backboard
- Scholastic 1000 breakaway rim
- CE: Grey glue-on backboard padding

SPECIALTY GLASS

Interested in updating your side courts? Love the play of glass, but don't have room for a 42" x 72" backboard and structures won't support the weight of a tall or short glass board? GARED offers **RECTANGULAR AND FAN-SHAPE GLASS** alternatives • Using the same quality of glass as our competition line of product, our specialty glass backboard line will fit your side court needs • Each backboard features a steel frame to provide optimal strength and 20" x 35" mounting patterns • **GARED'S LIMITED LIFETIME WARRANTY COVERS ALL SPECIALTY GLASS BACKBOARDS.**



3050RG

3050RG: 42" X 54" AUXILIARY RECTANGULAR GLASS SIDE COURT BACKBOARD

LIMITED LIFETIME WARRANTY, 4" X 5" HOLE SPACING,
WEIGHT: 175 LBS. (80 KGS.) TRUCK, FREIGHT CLASS 85, 24 HOUR SHIP

3050: 42" X 54" RECTANGULAR GLASS BACKBOARD WITH CORNER BRACKETS WITHOUT STRUTS

LIMITED LIFETIME WARRANTY, 4" X 5" HOLE SPACING,
WEIGHT: 168 LBS. (77 KGS.) TRUCK, FREIGHT CLASS 85, 24 HOUR SHIP



FSGII

FSGII: 39" X 54" AUXILIARY FAN-SHAPE GLASS BACKBOARD

LIMITED LIFETIME WARRANTY, 4" X 5" HOLE SPACING,
WEIGHT: 109 LBS. (50 KGS.) TRUCK, FREIGHT CLASS 85, 24 HOUR SHIP

SIDE COURT, PLAYGROUND, AND RECREATION BACKBOARDS



BB72G50HH

OUTDOOR GLASS BACKBOARDS

BB72G50HH: 42" X 72" OUTDOOR RECTANGULAR GLASS BACKBOARD

2 YEAR LIMITED WARRANTY, 5" X 5" HOLE SPACING,
WEIGHT: 195 LBS. (89 KGS.) TRUCK, FREIGHT CLASS 85, 24 HOUR SHIP

- 42" x 72" x 1/2" Glass backboard
- ClearView™ design

BB60G38HH: 42" X 60" OUTDOOR RECTANGULAR GLASS BACKBOARD

2 YEAR LIMITED WARRANTY, 5" X 5" HOLE SPACING,
WEIGHT: 195 LBS. (65 KGS.) (65 KGS.) TRUCK, FREIGHT CLASS 85, 24 HOUR SHIP

- 42" x 60" x 3/8" Glass backboard
- ClearView™ design

BB72G50: 42" X 72" OUTDOOR RECTANGULAR GLASS BACKBOARD

2 YEAR LIMITED WARRANTY, 5" X 5" HOLE SPACING,
WEIGHT: 195 LBS. (89 KGS.) TRUCK, FREIGHT CLASS 85, 24 HOUR SHIP

- 42" x 72" x 1/2" Glass backboard
- Strutted design

BB60G38: 42" X 60" OUTDOOR RECTANGULAR GLASS BACKBOARD

2 YEAR LIMITED WARRANTY, 5" X 5" HOLE SPACING,
WEIGHT: 195 LBS. (65 KGS.) TRUCK, FREIGHT CLASS 85, 24 HOUR SHIP

- 42" x 60" x 3/8" glass backboard
- Strutted design



BB72G50

WHEN CHOOSING A BACKBOARD NOT CONSTRUCTED WITH GLASS, UNDERSTANDING THE INHERENT CHARACTERISTICS OF THE MATERIAL WILL ENSURE YOU ARE PICKING THE CORRECT BACKBOARD TO CREATE AN OPTIMAL PLAY ENVIRONMENT.

POLYCARBONATE BACKBOARDS

GARED'S unbreakable **RECTANGULAR POLYCARBONATE BACKBOARD** is designed for the roughest indoor or outdoor play • Comprised of 1/2" thick UV-resistant polycarbonate permanently attached to a heavy duty welded steel tubular uni-frame with struts for added board support • Designed to allow for direct mounting with integral holes to permanently attach board to post and allow for goal replacement without removing board • Compatible mounting: Gooseneck & Straight-Arm Posts, Endurance Playground Systems • PlayRX™ Recommended Rims: 4000+, 3000, 2500, 2000+, 1000, 726, 5500 • For indoor or outdoor use.

BB72P50: 42" X 72" RECTANGULAR POLYCARBONATE BACKBOARD

LIMITED LIFETIME WARRANTY, 5" X 5" HOLE SPACING, WEIGHT: 195 LBS. (89 KGS.) TRUCK, FREIGHT CLASS 85, 24 HOUR SHIP



BB72P50

GARED'S line of durable **RECTANGULAR ACRYLIC BACKBOARDS** are versatile for indoor or outdoor use • Comprised of 3/8" thick UV-resistant acrylic permanently attached to a heavy duty welded steel tubular uni-frame with struts for added board support • Designed to allow for direct mounting with integral holes to permanently attach board to post and allow for goal replacement without removing board • Compatible mounting: Gooseneck & Straight-Arm Posts, Endurance Playground Systems • PlayRX™ Recommended Rims: 4000+, 3000, 2500, 2000+, 1000, 726, 5500 • For indoor or outdoor use.



BB72A38



BB60A38

BB72A38: 42" X 72" RECTANGULAR ACRYLIC BACKBOARD

2 YEAR LIMITED WARRANTY, 5" X 5" HOLE SPACING, WEIGHT: 111 LBS. (51 KGS.) TRUCK, FREIGHT CLASS 85, 24 HOUR SHIP

BB60A38: 42" X 60" RECTANGULAR ACRYLIC BACKBOARD

2 YEAR LIMITED WARRANTY, 5" X 5" HOLE SPACING, WEIGHT: 90 LBS. (41 KGS.) TRUCK, FREIGHT CLASS 85, 24 HOUR SHIP

BB48A38: 36" X 48" RECTANGULAR ACRYLIC BACKBOARD

2 YEAR LIMITED WARRANTY, 5" X 5" HOLE SPACING, WEIGHT: 78 LBS. (36 KGS.) TRUCK, FREIGHT CLASS 85, 24 HOUR SHIP

FIBERGLASS BACKBOARDS

Looking for superior rebounds on a non-glass surface? **GARED'S FAN-SHAPE & RECTANGULAR FIBERGLASS BACKBOARDS** are the answer for indoor or outdoor play • Features molded fiberglass for strength & superior rebounding surface • Screen printed target and border • Fan-shape and rectangular backboard molded inserts are positioned at 20" vertically by 35" horizontal centers for mounting • Compatible Mounting: Ceiling & Wall Mounted systems, Gooseneck & Straight-Arm Posts • PlayRX™ Recommended Rims: 8550, 5500, 8800, 7550, 240, 39WO • For indoor or outdoor use.

I342B: 42" X 72" RECTANGULAR FIBERGLASS BACKBOARD

WITH ORANGE TARGET AND BORDER

10 YEAR INDOOR/5 YEAR OUTDOOR LIMITED WARRANTY
5" X 5" TO 4 1/2" X 5" HOLE SPACING, WEIGHT: 86 LBS. (39 KGS.) TRUCK, FREIGHT CLASS 70, 24 HOUR SHIP



I342B

I342B-BLK: 42" X 72" RECTANGULAR FIBERGLASS BACKBOARD

WITH BLACK TARGET AND BORDER

10 YEAR INDOOR/5 YEAR OUTDOOR LIMITED WARRANTY
5" X 5" TO 4 1/2" X 5" HOLE SPACING, WEIGHT: 86 LBS. (39 KGS.) TRUCK, FREIGHT CLASS 70, 24 HOUR SHIP

I301B: 39" X 54" FAN-SHAPE FIBERGLASS BACKBOARD

WITH ORANGE TARGET AND BORDER

10 YEAR INDOOR/5 YEAR OUTDOOR LIMITED WARRANTY
5" X 5" & 3" X 4" HOLE SPACING, WEIGHT: 57 LBS. (26 KGS.) TRUCK, FREIGHT CLASS 70, 24 HOUR SHIP



I301B

STEEL BACKBOARDS

GAREDS' **STEEL LINE OF BACKBOARDS** are ideal for unsupervised and urban play environments • Steel provides an unyielding foundation for your outdoor system • Although the rebound effect of steel is the least similar to glass, the sturdiness of the material will stand up to the toughest competition • Our line of steel backboards feature every standard shape and size.

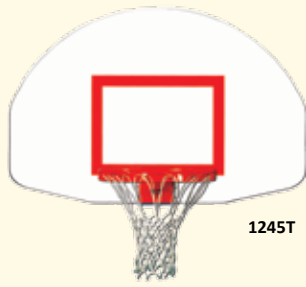

1245T

GAREDS' FRONT-MOUNT FAN-SHAPE STEEL BACKBOARDS provides the strongest backboard available for rugged playground use • 12 gauge steel shell with white powdercoat finish and optional screened target and border • Keyhole slots are positioned at 20" vertically by 35" horizontal centers for mounting • Features reinforced mounting points, including 2 safety mount holes, to reduce vibration • Compatible Mounting: Ceiling & Wall Mounted systems, Gooseneck & Straight-Arm Posts • PlayRX™ Recommended Rims: 8550, 5500, 8800, 7550, 240, 39WO • For indoor or outdoor use.

1245: 35" X 54" FRONT-MOUNT FAN-SHAPE STEEL BACKBOARD WITH WHITE POWDERCOAT FINISH
10 YEAR LIMITED WARRANTY, 4 1/2" X 5" HOLE SPACING, WEIGHT: 83 LBS. (38 KGS.) TRUCK, FREIGHT CLASS 70, 24 HOUR SHIP

1245T: 35" X 54" FRONT-MOUNT FAN-SHAPE STEEL BACKBOARD WITH ORANGE TARGET
10 YEAR LIMITED WARRANTY, 4 1/2" X 5" HOLE SPACING, WEIGHT: 83 LBS. (38 KGS.) TRUCK, FREIGHT CLASS 70, 24 HOUR SHIP

Our **REAR-MOUNT FAN-SHAPE STEEL BACKBOARDS** provide the sturdiest option for the playground • 12 gauge steel shell with white powdercoat finish and optional screened target and border • Keyhole slots are positioned at 20" vertically by 35" horizontal centers for mounting • Featured reinforced mounting points, including 2 safety mount holes, which reduces vibration • Compatible Mounting: Rear-Mount Gooseneck & Straight-Arm Posts • PlayRX™ Recommended Rims: 6600, 8566, 266, 66T • For outdoor use.

1266: 35" X 54" REAR-MOUNT FAN-SHAPE STEEL BACKBOARD WITH WHITE POWDERCOAT FINISH
5 YEAR LIMITED WARRANTY, 3 5/8" X 4" HOLE SPACING, WEIGHT: 83 LBS. (38 KGS.) TRUCK, FREIGHT CLASS 70, 24 HOUR SHIP

1266B: 35" X 54" REAR-MOUNT FAN-SHAPE STEEL BACKBOARD WITH ORANGE TARGET & BORDER
5 YEAR LIMITED WARRANTY, 3 5/8" X 4" HOLE SPACING, WEIGHT: 83 LBS. (38 KGS.) TRUCK, FREIGHT CLASS 70, 24 HOUR SHIP



1266B

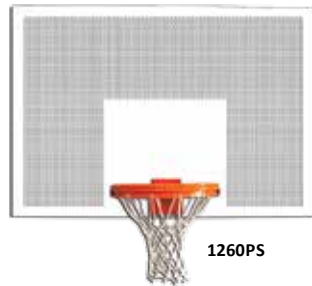

1260PS

GAREDS' PERFORATED STEEL BACKBOARDS are designed especially for outdoor use and ideal in windy locations • 11 gauge steel with 1/4" staggered perforations 1/2" apart allow increased airflow through the board for a truer ball bounce • Board is attached to a steel tubular frame for added support • Direct mounting design with integral holes allow permanent attachment of board to post and allow for goal replacement without removing board • Compatible Mounting: Gooseneck & Straight-Arm Posts • PlayRX™ Recommended Rims: 8550, 5500, 8800, 7550, 240, 39WO • For outdoor use.

1260PS: 42" X 60" RECTANGULAR PERFORATED STEEL BACKBOARD WITH WHITE POWDERCOAT FINISH
10 YEAR LIMITED WARRANTY, 5" X 5" HOLE SPACING, WEIGHT: 111 LBS. (51 KGS.) TRUCK, FREIGHT CLASS 70, 24 HOUR SHIP

1272PS: 42" X 72" RECTANGULAR PERFORATED STEEL BACKBOARD WITH WHITE POWDERCOAT FINISH
10 YEAR LIMITED WARRANTY, 5" X 5" HOLE SPACING, WEIGHT: 134 LBS. (61 KGS.) TRUCK, FREIGHT CLASS 70, 24 HOUR SHIP

Our durable **RECTANGULAR STEEL BACKBOARDS** are built strong for rugged playground use. • 12 gauge steel shell with white powdercoat finish and optional target and border • Constructed with an integral reinforcing steel channel on reverse side for mounting and increased board support • 20" x 35" mounting centers for attaching board to structure • Capable of direct mounting with integral keyhole slots to permanently attach board to post and allow for goal replacement without removing board • Compatible Mounting: Gooseneck & Straight-Arm Posts • PlayRX™ Recommended Rims: 8550, 5500, 8800, 7550, 240, 39WO • For indoor or outdoor use.

1260: 42" X 60" RECTANGULAR STEEL BACKBOARD WITH WHITE POWDERCOAT FINISH
10 YEAR LIMITED WARRANTY, 5" X 5" HOLE SPACING, WEIGHT: 112 LBS. (51 KGS.) TRUCK, FREIGHT CLASS 70, 24 HOUR SHIP

1260B: 42" X 60" RECTANGULAR STEEL BACKBOARD WITH ORANGE TARGET & BORDER
10 YEAR LIMITED WARRANTY, 5" X 5" HOLE SPACING, WEIGHT: 112 LBS. (51 KGS.) TRUCK, FREIGHT CLASS 70, 24 HOUR SHIP

1272: 42" X 72" RECTANGULAR STEEL BACKBOARD WITH WHITE POWDERCOAT FINISH
10 YEAR LIMITED WARRANTY, 5" X 5" HOLE SPACING, WEIGHT: 131 LBS. (60 KGS.) TRUCK, FREIGHT CLASS 70, 24 HOUR SHIP

1272B: 42" X 72" RECTANGULAR STEEL BACKBOARD WITH ORANGE TARGET & BORDER
10 YEAR LIMITED WARRANTY, 5" X 5" HOLE SPACING, WEIGHT: 131 LBS. (60 KGS.) TRUCK, FREIGHT CLASS 70, 24 HOUR SHIP

1270: 48" X 72" RECTANGULAR STEEL BACKBOARD WITH WHITE POWDERCOAT FINISH
10 YEAR LIMITED WARRANTY, 5" X 5" HOLE SPACING, WEIGHT: 147 LBS. (67 KGS.) TRUCK, FREIGHT CLASS 70, 24 HOUR SHIP

1270B: 48" X 72" RECTANGULAR STEEL BACKBOARD WITH ORANGE TARGET & BORDER
10 YEAR LIMITED WARRANTY, 5" X 5" HOLE SPACING, WEIGHT: 147 LBS. (67 KGS.) TRUCK, FREIGHT CLASS 70, 24 HOUR SHIP

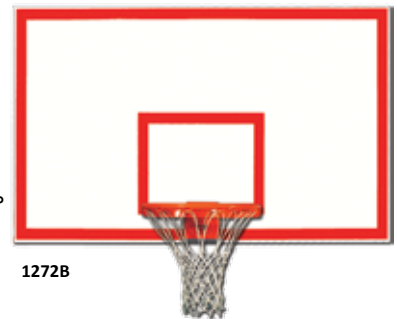

1272B



1260B

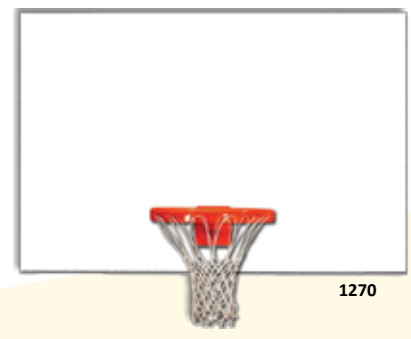

1270

GARED'S FAN-SHAPE ALUMINUM BACKBOARDS are the perfect solution for those concerned with backboard longevity • Constructed of casted aluminum, GARED'S backboards provide a light-weight alternative for every indoor and playground setting • To help eliminate rim replacement injuries, our backboards feature two additional mounting holes to hold the backboard in place • **EACH ALUMINUM BACKBOARD QUALIFIES FOR GARED'S LIMITED LIFETIME WARRANTY.**

FEATURES:

- Front-Mount rim compatible
- 20" x 35" mounting pattern
- 12 reinforced mounting points
- Threaded inserts
- Safety mounting holes
- Natural and powdercoat finishes available

1701: 35 1/2" X 54" FAN-SHAPE ALUMINUM BACKBOARD WITH BRUSHED FINISH

LIMITED LIFETIME WARRANTY, 4 1/2" X 5" HOLE SPACING, WEIGHT: 49 LBS. (23 KGS.) GROUND COURIER SERVICE, 24 HOUR SHIP

1750: 35 1/2" X 54" FAN-SHAPE ALUMINUM BACKBOARD WITH WHITE POWDERCOAT FINISH

LIMITED LIFETIME WARRANTY, 4 1/2" X 5" HOLE SPACING, WEIGHT: 49 LBS. (23 KGS.) GROUND COURIER SERVICE, 24 HOUR SHIP

1750B: 35 1/2" X 54" FAN-SHAPE BACKBOARD ALUMINUM BACKBOARD WITH ORANGE TARGET AND BORDER

LIMITED LIFETIME WARRANTY, 4 1/2" X 5" HOLE SPACING, WEIGHT: 49 LBS. (23 KGS.) GROUND COURIER SERVICE, 24 HOUR SHIP



1750B



1701



1750

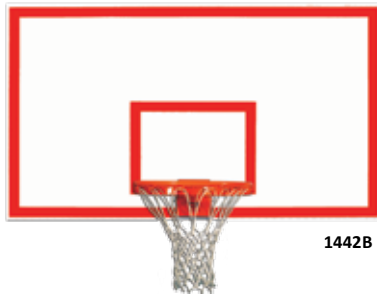

1442B

Our retro **RECTANGULAR WOOD BACKBOARDS** are the traditional, economic alternative to other non-glass backboards • 1 1/2" thermally fused melamine with durable screened target and border • Keyhole slots are positioned at 42" vertically by 63" horizontal centers for mounting • Compatible Mounting: Ceiling & Wall Mounted systems • PlayRX™ Recommended Rims: 2000+, 1000, 240, 39WO • For indoor use only.

1442B: 42" X 72" RECTANGULAR WOOD BACKBOARD WITH ORANGE TARGET AND BORDER

2 YEAR LIMITED WARRANTY, 4" X 5" HOLE SPACING, WEIGHT: 145 LBS. (66 KGS.) TRUCK, FREIGHT CLASS 70, 24 HOUR SHIP

HOLE PATTERNS

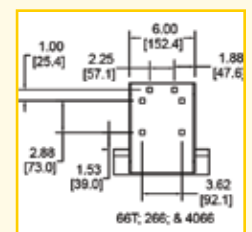
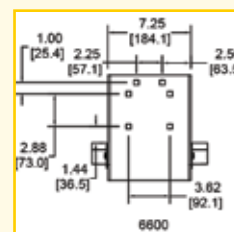
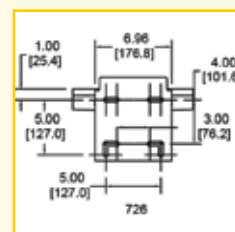
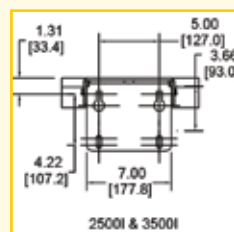
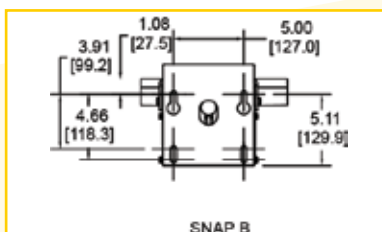
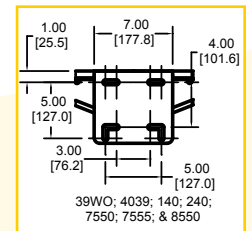
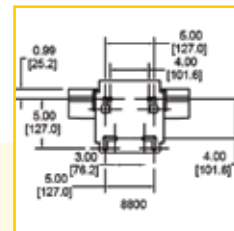
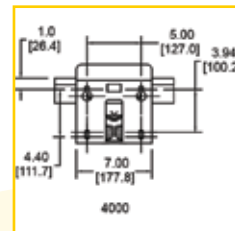
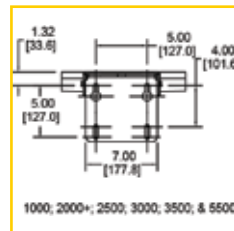
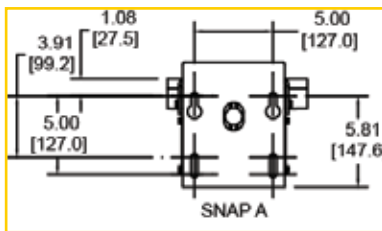



PMCE



SAFEGUARD YOUR PLAYERS WITH GARED'S PRO-MOLD® BOLT-ON BACKBOARD PADDING.

GARED'S BACKBOARD PADDING offers an unmatched combination of softness to touch, yet durability to last • Better yet - GARED'S padding passes the flexibility test • You can bend it and the corners won't tear unlike our competitors product • With an array of 16 vibrant colors, we cover a component of every institution's school color scheme • Our padding will universally fit any 72" backboard with a 2" channel • Our bolt-on padding's installation is simple with the included durable bolt hardware and sag-resistant center rod • One pad kit protects one backboard, order a pair for a court Padding meets all FIBA, NCAA, NBA, NFHS & CSPC specifications.

PMCE: GARED PRO-MOLD® BACKBOARD PADDING
10 YEAR LIMITED WARRANTY, WEIGHT: 10 LBS/EACH (5 KGS.), GROUND COURIER SERVICE, 24 HOUR SHIP



The **PRO-MOLD® RECREATIONAL BACKBOARD PADDING** is made specifically for outdoor use • Durable polyurethane foam designed for long life in heavy play environments and resistance to weather elements • Bolts to metal framing using self tapping screws on outdoor rectangular backboards • Available for 48", 54", 60", and 72" boards • Available in black only.

LSCE48: 48" PRO-MOLD RECREATIONAL BACKBOARD PADDING
1 YEAR LIMITED WARRANTY, WEIGHT: 7 LBS (4 KGS.)
GROUND COURIER SERVICE, 24 HOUR SHIP

LSCE54: 54" PRO-MOLD RECREATIONAL BACKBOARD PADDING
1 YEAR LIMITED WARRANTY, WEIGHT: 7 LBS (4 KGS.)
GROUND COURIER SERVICE, 24 HOUR SHIP

LSCE60: 60" PRO-MOLD RECREATIONAL BACKBOARD PADDING
1 YEAR LIMITED WARRANTY, WEIGHT: 8 LBS (4 KGS.)
GROUND COURIER SERVICE, 24 HOUR SHIP

LSCE72: 72" PRO-MOLD RECREATIONAL BACKBOARD PADDING
1 YEAR LIMITED WARRANTY, WEIGHT: 9 LBS (5 KGS.)
GROUND COURIER SERVICE, 24 HOUR SHIP



PSCE

PSCE AVAILABLE IN GREY ONLY

DO YOU WANT TO PROTECT YOUR PLAYERS FROM INJURY, BUT YOUR FACILITY'S BUDGET IS A LITTLE TIGHT? GARED OFFERS AN EASY ALTERNATIVE.

The **CUSHION EDGE BACKBOARD PADDING** is an economic alternative to GARED's PRO-MOLD® padding • Attaches to the bottom of backboards with brushed on adhesive, no bolting required • High-density open cell foam rubber pad • Mitered corners for exact fit • Extends 18" up on each side of a backboard • Meets NCAA and NFHS specifications • For indoor use • Available in grey only.

CE-PR: GLUE-ON BACKBOARD PADDING
 1 YEAR LIMITED WARRANTY, WEIGHT: 13 LBS/PAIR (6 KGS.)
 GROUND COURIER SERVICE, 24 HOUR SHIP



The **NARROW CHANNEL BACKBOARD PADDING** fits rectangular fiberglass, steel and wood backboards • Attaches to bottom of backboards with brushed on adhesive, no bolting required • High-density open cell foam rubber pad • Mitered corners for exact fit • Extends 18" up on each side of a backboard • Meets NCAA and NFHS specifications • For indoor use • Available in grey only.

NCE-PR: NARROW CHANNEL BACKBOARD PADDING
 1 YEAR LIMITED WARRANTY, WEIGHT: 14 LBS/PAIR (7 KGS.)
 GROUND COURIER SERVICE, 24 HOUR SHIP

PLAYRX™ BACKBOARD PADDING PRODUCT GUIDE

MODEL	PMCE	CE	NCE	LSCE
GLASS BACKBOARDS				
3010RG	X			
3011RG	X			
AFRG42	X	X		
AFRG42E	X	X		
AFRG48	X	X		
LXP4200	X	X		
RG	X	X		
ARG	X	X		
3050/RG		X		
FSGII		X		
OUTDOOR GLASS BACKBOARDS				
BB60G38HH				X
BB72G50HH				X
BB60G38				X
BB72G50				X
ACRYLIC & POLYCARBONATE BACKBOARDS				
BB48A38				X
BB60A38				X
BB72A38				X
BB72P50				X
STEEL BACKBOARDS				
I245				
I245T				
I266				
I266B				
I260			X	X
I260B			X	X
I260PS			X	X
I272			X	X
I272B			X	X
I272PS			X	X
I270			X	X
I270B			X	X
FIBERGLASS BACKBOARDS				
I301B				
I342B			X	
WOOD BACKBOARDS				
I442B			X	
I401B			X	
ALUMINUM BACKBOARDS				
I701				
I750/B				

COMPETITION BREAKAWAY RIMS

From Pro Arenas to your local YMCA, **GARED'S LINE OF BREAKAWAY RIMS** offer high quality engineering to fit every player's & facility's need • Each of our competition rims share basic features of 5/8" single ring goal, strengthening full steel wing braces, CSPC tested orange powdercoat, an adjustable internal spring, and breakaway mechanism - meeting NBA, NCAA, NFHS specifications • Additionally, the hole pattern configurations allow for nearly universal compatibility with all other 42" x 72" backboards regardless of manufacture • Each rim is shipped with mounting hardware and official anti-whip net within 24 hours of order • While sharing a solid engineered foundation, each rim has sophisticated features to match your facility's specific needs, such as positive lock pressure settings, net attachment type and fly back control.



Breakaway from the competition with **GARED'S 180 MDG (MULTI-DIRECTIONAL) RIM** • Our exclusive 3-way positive lock mechanism makes GARED'S revolutionary MDG the top pick for any facility looking for a non-traditional breakaway rim • Putting the safety of your players first, the MDG will not dangerously break upward if a player inadvertently hits it from underneath the ring • Our internal sophisticated torque mechanism will withstand the rigors of constant, high energy play • The rim's tube-tie net attachment helps lengthen the life of our anti-whip nets • Meets NCAA, NFHS & NAIA specifications • Adjustable positive lock mechanism complies with NCAA rim elasticity rule.

4000+: GARED 4000+ MDG BREAKAWAY GOAL WITH NYLON NET FOR 42" X 72" GLASS BACKBOARDS
5 YEAR LIMITED WARRANTY ON RIM, 4" X 5" HOLE SPACING,
WEIGHT: 24 LBS. (12 KGS.) GROUND COURIER SERVICE, 24 HOUR SHIP GUARANTEE

4000I: GARED 4000 INTERNATIONAL MDG BREAKAWAY GOAL WITH NYLON NET FOR 42" X 72" GLASS BACKBOARDS
5 YEAR LIMITED WARRANTY ON RIM, 4" X 5" HOLE SPACING,
WEIGHT: 24 LBS. (12 KGS.) GROUND COURIER SERVICE, 24 HOUR SHIP GUARANTEE

Our **SNAP BACK™ BREAKAWAY GOALS** have been a staple in pro arenas for over 2 decades • These top of the line goals feature a positive lock mechanism that can't be matched in quality nor duplicated in functionality • Pressure set at 210 lbs - the **GARED SNAP BACK RIMS** are designed to withstand the rigors of abuse from highly skilled players • Each rim features a tie-cord net attachment to help prevent hand injuries • The Snap B backplate universally fits 42" backboards; Snap A backplate universally fits 48" boards.

SNAP B: GARED SNAP BACK®, PRO ARENA GOAL WITH NYLON NET FOR 42" X 72" GLASS BACKBOARDS
10 YEAR LIMITED WARRANTY ON BREAKAWAY MECHANISM, 5 YEAR LIMITED WARRANTY ON RIM, 4 1/2" X 5" HOLE SPACING, WEIGHT: 26 LBS. (12 KGS.) GROUND COURIER SERVICE, 24 HOUR SHIP GUARANTEE

SNAP A: GARED SNAP BACK®, PRO ARENA GOAL WITH NYLON NET FOR 48" X 72" GLASS BACKBOARDS
10 YEAR LIMITED WARRANTY ON BREAKAWAY MECHANISM, 5 YEAR LIMITED WARRANTY ON RIM, 5" X 5" HOLE SPACING, WEIGHT: 26 LBS. (12 KGS.) GROUND COURIER SERVICE, 24 HOUR SHIP GUARANTEE

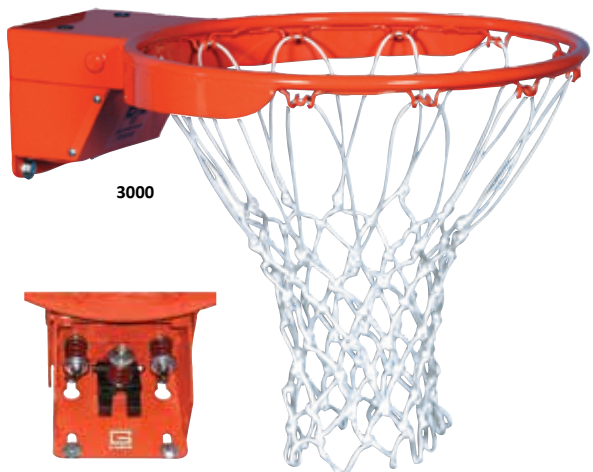

If you are planning to cut down your nets this season, **GARED'S MASTER 3000® BREAKAWAY SERIES** is a great backdrop • A court champion selection outside of NBA arenas • The 3000's breakaway mechanism is set to break at 160 lbs of pressure • The hefty construction and architecture of the goal creates an unparalleled playing surface for any facility environment • Heat-treated ball bearings and steel hardened springs create a positive lock pressure setting allowing precise fly-back action • The popular 3000 offers the ease of net installation with its no-tie net attachment • The 3500 & 3500I's tube-tie net attachment helps prevent hand injury.

3000: GARED MASTER 3000® BREAKAWAY GOAL WITH NYLON NET
10 YEAR LIMITED WARRANTY ON BREAKAWAY MECHANISM, 4 YEAR LIMITED WARRANTY ON RIM, 4" X 5" HOLE SPACING, WEIGHT: 26 LBS. (12 KGS.) GROUND COURIER SERVICE, 24 HOUR SHIP GUARANTEE

3500: GARED MASTER 3500® BREAKAWAY GOAL WITH NYLON NET
10 YEAR LIMITED WARRANTY ON BREAKAWAY MECHANISM, 4 YEAR LIMITED WARRANTY ON RIM, 4" X 5" HOLE SPACING, WEIGHT: 26 LBS. (12 KGS.) GROUND COURIER SERVICE, 24 HOUR SHIP GUARANTEE

3500I: GARED MASTER 3500I® FIBA INTERNATIONAL BREAKAWAY GOAL WITH NYLON NET
10 YEAR LIMITED WARRANTY ON BREAKAWAY MECHANISM, 4 YEAR LIMITED WARRANTY ON RIM, 4" X 5" HOLE SPACING, WEIGHT: 26 LBS. (12 KGS.) GROUND COURIER SERVICE, 24 HOUR SHIP GUARANTEE



GARED'S CELEBRATED COLLEGIATE SERIES OF GOALS can be found in almost every facility around the world • Superbly constructed, the **2000+**, **2500** & **2500I** stand-up to the rigors of power players – making them our most popular line of rims • Each rim features an effective positive lock mechanism duplicating precision fly-back action dunk after dunk • The best-selling **2000+** offers the ease of net installation with its no-tie net attachment • The **2500** & **2500I** tube-tie net attachments helps prevent hand injury • Due to their universal backplates, the collegiate goal series seamlessly fits on any size glass backboard.

2000+: GARED COLLEGIATE 2000 BREAKAWAY GOAL WITH NYLON NET
4 YEAR LIMITED WARRANTY, 4" X 5" HOLE SPACING, WEIGHT: 25 LBS. (12 KGS.)
GROUND COURIER SERVICE, 24 HOUR SHIP GUARANTEE

2500: GARED TOURNAMENT BREAKAWAY GOAL WITH NYLON NET
4 YEAR LIMITED WARRANTY, 4" X 5" HOLE SPACING, WEIGHT: 25 LBS. (12 KGS.)
GROUND COURIER SERVICE, 24 HOUR SHIP GUARANTEE

2500I: INTERNATIONAL TOURNAMENT BREAKAWAY GOAL WITH NYLON NET
4 YEAR LIMITED WARRANTY, 4" X 5" HOLE SPACING, WEIGHT: 25 LBS. (12 KGS.)
GROUND COURIER SERVICE, 24 HOUR SHIP GUARANTEE



2000+



1000



2500



2500I

Sporting an accordion-like breakaway action, the **SCHOLASTIC FLEX RIM** is a great alternative to a facility needing an institutional quality breakaway rim without a positive lock mechanism • Superiorly constructed, the **1000 BREAKAWAY FLEX GOAL** fits perfectly in every setting from playground to elementary courts to recreational facilities • The Scholastic rim's no-tie attachment and universal backplate make it the most compatible option for any play situation.

1000: GARED SCHOLASTIC FLEX BREAKAWAY GOAL WITH NYLON NET
2 YEAR LIMITED WARRANTY, 4" X 5" HOLE SPACING, WEIGHT: 23 LBS. (11 KGS.)
GROUND COURIER SERVICE, 24 HOUR SHIP GUARANTEE

RECREATIONAL FRONT-MOUNT BREAKAWAY GOALS

GARED'S LINE OF RECREATIONAL FLEX BREAKAWAYS are designed with the challenges of outdoor elements in mind • Constructed to last through every storm, all of our rims feature CSPC compliant powdercoated finish • Regardless of budget, application or climate – we will help you score! • Understanding that everyone wants to dunk regardless of setting, our recreational breakaways will protect your backboards from the stress of heavy, unsupervised play.

The **8800 ENDURANCE BREAKAWAY SLAM** is the last playground goal you will ever need • 18" double rings • unique 3/4" top ring & 5/8" bottom ring • thick & continuous wing-brace • double spring flex breakaway mechanism • t-tie net attachment protects players from hand injuries & increases net security • Includes GGN nylon net & hardware.

8800: ENDURANCE BREAKAWAY SLAM GOAL WITH NYLON NET
2 YEAR LIMITED WARRANTY, 5" X 4" HOLE SPACING, WEIGHT: 30 LBS. (14 KGS.)
GROUND COURIER SERVICE, 24 HOUR SHIP GUARANTEE



8800



5500

The **5500 DOUBLE RING PLAYGROUND BREAKAWAY GOAL** is a durable, double rim goal for playground environments • 18" double rings • dual 5/8" rings • Extended wing brace • Double spring flex breakaway mechanism • No-tie net attachment for installation ease • Includes GGN nylon net & hardware.

5500: PLAYGROUND BREAKAWAY GOAL WITH NYLON NET
2 YEAR LIMITED WARRANTY, 4-5" X 5" HOLE SPACING, WEIGHT: 27 LBS. (13 KGS.)
GROUND COURIER SERVICE, 24 HOUR SHIP GUARANTEE

The **TITAN POWER AND TITAN PLUS BREAKAWAY GOAL** are affordable goals that provide durability and performance • 18" single ring • 5/8" ring • Extended wing brace • Single spring flex breakaway mechanism • No-tie net attachment for installation ease • Includes GGN nylon net & hardware.

726: TITAN PLUS BREAKAWAY GOAL WITH NYLON NET

1 YEAR LIMITED WARRANTY, 4-5" X 5" HOLE SPACING, WEIGHT: 20 LBS. (9 KGS.) GROUND COURIER SERVICE, 24 HOUR SHIP GUARANTEE

724: TITAN POWER BREAKAWAY GOAL WITH NYLON NET

1 YEAR LIMITED WARRANTY, 4-5" X 5" HOLE SPACING, WEIGHT: 20 LBS. (9 KGS.) GROUND COURIER SERVICE, 24 HOUR SHIP GUARANTEE



FRONT-MOUNT FIXED GOALS

Understanding the anatomy of a Front-Mount fixed rim is the first step in choosing the correct fit for your needs • A fixed rim is comprised of 4 basic components: ring, bracing, net attachment and back-plate • As you add rings, ring diameter and strengthen bracing, you are building a stronger rim • Most of **GARED'S FIXED GOALS** are double-ringed rims, with various levels of bracing • All rims feature universal backplates and ship with an outdoor quality net • While all of our fixed goals feature universal hole patterns, we do not encourage putting fixed rims on glass backboards.

The **8550 ENDURANCE SLAM GOAL** is the toughest rim for hard hitting players • 18" double rings • unique 3/4" top ring & 5/8" bottom ring • thick & continuous wing-brace • T-tie net attachment protects players from hand injuries & increases net security • Includes GGN nylon net & hardware.

8550: ENDURANCE SLAM GOAL WITH NYLON NET

LIMITED LIFETIME WARRANTY, 5" X 5" HOLE SPACING, WEIGHT: 27 LBS. (13 KGS.) GROUND COURIER SERVICE, 24 HOUR SHIP GUARANTEE



7550

8550

The **7550 TITAN PLAYGROUND SUPER GOAL** are the most durable rims in the industry • 18" double rings • 1/2" top ring & 3/4" bottom ring • 5/8" wing plates and 5/8" x 15" bracing • Includes net & hardware.

7550: TITAN SUPER GOAL WITH NYLON NET

LIMITED LIFETIME WARRANTY, 5" X 5" HOLE SPACING, WEIGHT: 25 LBS. (11 KGS.) GROUND COURIER SERVICE, 24 HOUR SHIP GUARANTEE

The **240 & 140 FRONT-MOUNT SUPER GOALS** offer affordable, yet superior playground performance • 18" double rings • 5/8" top ring & 1/2" bottom ring • Dual 1/2" x 15" bracing • No-tie net attachment for installation ease • Includes net & hardware.

240: SUPER GOAL WITH NYLON NET

2 YEAR LIMITED WARRANTY, 5" X 5" HOLE SPACING, WEIGHT: 18 LBS. (9 KGS.) GROUND COURIER SERVICE, 24 HOUR SHIP GUARANTEE

140: SUPER GOAL WITH SCN CHAIN NET

2 YEAR LIMITED WARRANTY, 5" X 5" HOLE SPACING, WEIGHT: 19 LBS. (9 KGS.) GROUND COURIER SERVICE, 24 HOUR SHIP GUARANTEE

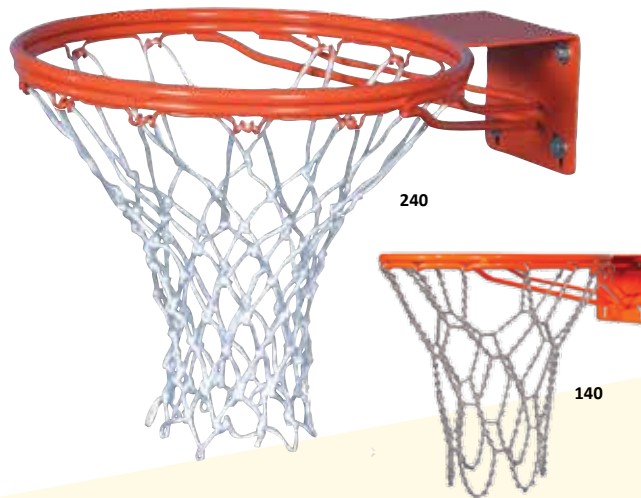

240

140



39WO

The **39WO & 4039 INSTITUTIONAL FRONT-MOUNT GOALS** are the best selling, economical, multi-use stationary goals • 18" single ring • 5/8" ring • Single 5/8" x 15" bracing • No-tie net attachment for installation ease • Includes GGN nylon net & hardware.

39WO: INSTITUTIONAL GOAL WITH NYLON NET

1 YEAR LIMITED WARRANTY, 5" X 5" HOLE SPACING, WEIGHT: 13 LBS. (6 KGS.)
GROUND COURIER SERVICE, 24 HOUR SHIP GUARANTEE

4039: HIGH STRENGTH INSTITUTIONAL GOAL WITH NYLON NET

3 YEAR LIMITED WARRANTY, 5" X 5" HOLE SPACING, WEIGHT: 13 LBS. (6 KGS.)
GROUND COURIER SERVICE, 24 HOUR SHIP GUARANTEE

REAR-MOUNT GOALS

REAR-MOUNT BASKETBALL GOALS are designed to increase the life span of rear-mount backboards

- With a backward "L" design, the rim connects to the backboard from behind, eliminating the chance of damaging the protective powdercoat on the front of the board
- When connected to a gooseneck or straight-armed post, the rear-mount configuration is the strongest available on the playground
- Due to their unique design, rear-mount goals are only compatible with rear-mount backboards
- To make ordering easy, GARED'S Rear-Mount backboards & goals include a "66" in the product part number.

The **6600 SCHOLASTIC REAR-MOUNT BREAKAWAY GOAL** is the brawniest Rear-Mount goal available for playgrounds • Single 5/8" rings • Extended wing brace • Double spring flex breakaway mechanism • No-tie net attachment for installation ease • Includes GGN nylon net & hardware.

6600: SCHOLASTIC REAR-MOUNT BREAKAWAY GOAL WITH NYLON NET

2 YEAR LIMITED WARRANTY, 3 5/8" X 4" HOLE SPACING, WEIGHT: 26 LBS. (12 KGS.)
GROUND COURIER SERVICE, 24 HOUR SHIP GUARANTEE



6600



266

The **266 REAR-MOUNT SUPER GOAL** is an affordable yet superior performance playground goal • 18" double rings • 5/8" top ring & 1/2" bottom ring • Dual 5/8" x 15" bracing • No-tie net attachment for installation ease • Includes nylon net & hardware.

266: REAR-MOUNT SUPER GOAL WITH NYLON NET

2 YEAR LIMITED WARRANTY, 3 5/8" X 4" HOLE SPACING, WEIGHT: 20 LBS. (9 KGS.)
GROUND COURIER SERVICE, 24 HOUR SHIP GUARANTEE



66T

The **66T AND 4066 INSTITUTIONAL REAR-MOUNT FIXED GOALS** are the best selling, economical, multi-use fixed goals • 18" single ring • 5/8" ring • Single 5/8" x 15" bracing • No-tie net attachment for installation ease.

66T: INSTITUTIONAL REAR-MOUNT GOAL WITH NYLON NET

1 YEAR LIMITED WARRANTY, 3 5/8" X 4" HOLE SPACING, WEIGHT: 18 LBS. (9 KGS.)
GROUND COURIER SERVICE, 24 HOUR SHIP GUARANTEE

4066: HIGH STRENGTH INSTITUTIONAL REAR-MOUNT GOAL WITH NYLON NET

3 YEAR LIMITED WARRANTY, 3 5/8" X 4" HOLE SPACING, WEIGHT: 18 LBS. (9 KGS.)
GROUND COURIER SERVICE, 24 HOUR SHIP GUARANTEE

SPECIALTY GOALS

The **26WO SPECIALTY PORTABLE GOAL** is the replacement goal for MINI-EZ portable units • Front-Mount 5/8" x 18" single rim • Continuous no-tie net attachment • Goal is powdercoated to protect from environmental elements • Includes GGN nylon net and mounting hardware • Recommended Backboards: GP4832ISQ.

26WO: GARED SPECIALTY PORTABLE GOAL WITH NYLON NET

1 YEAR LIMITED WARRANTY, 4" X 3 1/2" HOLE SPACING WEIGHT: 9 LBS. GROUND COURIER SERVICE, 24 HOUR SHIP

PRACTICE GOALS are the perfect novelty goals for carnivals and accuracy drills • Continuous no-tie net attachment • Goal is powdercoated to protect from environmental elements • Includes GGN nylon net and mounting hardware.

13P: 13" PRACTICE GOAL WITH NYLON NET

1 YEAR LIMITED WARRANTY, 2" X 4 1/2" HOLE SPACING, WEIGHT: 8 LBS. GROUND COURIER SERVICE, 24 HOUR SHIP

15P: 15" PRACTICE GOAL WITH NYLON NET

1 YEAR LIMITED WARRANTY, 2" X 4 1/2" HOLE SPACING, WEIGHT: 9 LBS. GROUND COURIER SERVICE, 24 HOUR SHIP

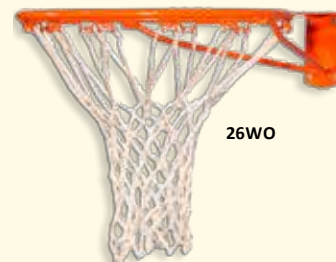

26WO

MULTI-LEVEL OF PLAY BASKETBALL NETS

GARED BASKETBALL NETS are pre-packaged for attractive retail display.

GARED'S AWP is the net of choice for professional play • 120 count nylon, hourglass design • Stiffened upper loops helps keep net from whipping up through goal • Includes tie cord • For use with the Snap A & B rims • Packaged in dozens, order minimum is 6 dozen.

AWP: ANTI-WHIP PRO BASKETBALL NET

WEIGHT: 1 LB. GROUND COURIER SERVICE, 24 HOUR SHIP

THE GAW is a top quality net used for collegiate & recreational play • 120 count nylon, hourglass design • Fits all 12 loop, no-tie goals • Stiffened upper loops helps keep net from whipping up through goal • Packaged in dozens, order minimum is 6 dozen.

GAW: ANTI-WHIP BASKETBALL NET

WEIGHT: 1 LB. (1 KG.) GROUND COURIER SERVICE, 24 HOUR SHIP

The **GGN** is the leading net used in recreational and outdoor play • 120 count nylon, hourglass design • Fits all 12 loop, no-tie goals • Packaged in dozens, order minimum is 6 dozen.

GGN: RECREATIONAL BASKETBALL NET

WEIGHT: 1 LB. (1 KG.) GROUND COURIER SERVICE, 24 HOUR SHIP

GARED'S CHAIN NET SERIES are designed to be used in rugged play environments • Will not stretch, tangle, shrink or break easily.

WCN: WELDED STEEL CHAIN BASKETBALL NET FOR DOUBLE RING GOALS

WEIGHT: 1 LB. (1 KG.) GROUND COURIER SERVICE, 24 HOUR SHIP

SCN: STEEL CHAIN BASKETBALL NET FOR DOUBLE BUMPED-RING GOALS

WEIGHT: 1 LB. (1 KG.) GROUND COURIER SERVICE, 24 HOUR SHIP

CN: STEEL CHAIN BASKETBALL NET FOR GOALS WITH NO-TIE NET ATTACHMENT

WEIGHT: 1 LB. (1 KG.) GROUND COURIER SERVICE, 24 HOUR SHIP

The **WEB NET** offers a safer alternative to chain nets on playgrounds • Nylon web design • Fits all 12 loop, no-tie goals • Will not rot or decay • Includes "S" hooks for rim attachment.

WN: WEB NYLON PLAYGROUND BASKETBALL NET

WEIGHT: 3 LBS. (2 KGS.) GROUND COURIER SERVICE, 24 HOUR SHIP

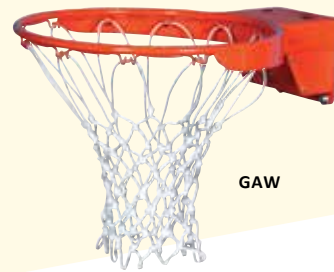

GAW



GGN



AWP



SCN



WCN



WN

BASKETBALL BALL STORAGE & SCOREBOOKS

The **DELUXE BALL CAGE** is a welded wire ball locker with a heavy chrome plated steel frame • Powdercoated black for superior protection • Lockable hinged cover • Non-marring swivel casters • Overall dimensions: 36" high x 41" wide x 24" deep.

DBC: DELUXE BALL CAGE

1 YEAR LIMITED WARRANTY, WEIGHT: 37 LBS. GROUND COURIER SERVICE, 24 HOUR SHIP

GARED'S BALL RACKS are sturdy storage options, made of 1" O.D., 18 gauge chrome-plated steel tubing • Unit rolls easily on 4 non-marring 2" casters for use on hardwood and synthetic floors.

BR-16: 4 TIER BALL RACK, 16 BALL CAPACITY

1 YEAR LIMITED WARRANTY, 51 3/4" H X 41" W X 24" D
WEIGHT: 18 LBS. (9 KGS.) GROUND COURIER SERVICE, 24 HOUR SHIP

BR-12: 3 TIER BALL RACK, 12 BALL CAPACITY

1 YEAR LIMITED WARRANTY, 39 3/4" H X 41" W X 14" D
WEIGHT: 14 LBS. GROUND COURIER SERVICE, 24 HOUR SHIP

The **MARK V BASKETBALL SCOREBOOK** is the industry standard for accurate basketball scoring • Simplified scoring instructions for basketball • 8 1/2" x 12" spiral bound hard back, horizontal layout • Packaged in dozens, order minimum is 4 dozen.

MARKV: MARK V SCOREBOOKS

WEIGHT: 8 LBS/DOZEN, GROUND COURIER SERVICE, 24 HOUR SHIP



DBC



BR-16



BR-12

The **VARSITY TOSS BACK®** is recognized as the best piece of equipment for use as a basketball training aid and for skill development • The Varsity Toss Back® can dramatically improve a player's quickness, strength, stamina and passing accuracy • Many coaches use multiple units for drills and some of the best programs in the country own as many as 14 Toss Backs® for individual player workouts • Net frame adjusts to varying angles for different types of practice drills • The roll around base uses casters for easy mobility and stability • Unit easily locks into place using a hand lever brake • Net frame is 38" x 51" and height can be adjusted from 4' 5" to 7'4" • DVD and skill development books on using **TOSS BACKS®** are available upon request.

VARSITY: VARSITY TOSS BACK®

2 YEAR LIMITED WARRANTY. WEIGHT: 141 LBS. (64 KGS.) TRUCK, FREIGHT CLASS 70, 24 HOUR SHIP

VRK: VARSITY REPLACEMENT NET & BANDS

WEIGHT: 2 LBS. (1 KG.) GROUND COURIER SERVICE, 24 HOUR SHIP

The **MASTER TOSS BACK®** unit offers the same durability and training benefits as the Varsity Toss Back® at an economical price • Designed primarily for basketball, but it can be used for many sports and physical education programs. • Wide legs with suction cups make the unit stable • Unit folds tight for efficient storage • Can be adjusted for many different drills • DVD and skill development books on using **TOSS BACK®** are available upon request.

MASTER: MASTER TOSS BACK®

1 YEAR LIMITED WARRANTY, WEIGHT: 35 LBS. TRUCK, GROUND COURIER SERVICE, 24 HOUR SHIP

The **PLAYMAKER TOSS BACK®** is an economical home and recreational skill development tool • Great for developing skills for many sports • Fully adjustable multi-sport ball return • Wide legs weighted foot pads make the unit stable • DVD and skill development books on using **TOSS BACK®** are available upon request.

PLAYMAKER: PLAYMAKER TOSS BACK®

1 YEAR LIMITED WARRANTY, WEIGHT: 31 LBS. TRUCK, GROUND COURIER SERVICE, 24 HOUR SHIP



VARSITY



MASTER



MASTER & PLAYI
NET ATTACHEM!



PLAYMAKER



The **STEEL PRACTICE RING** reduces the size of the basket goal to help improve shooting accuracy • Reduces goal from standard 18" to 17" • Attaches to any 18" rim • Goal is powdercoated to protect from environmental elements.

PR: PRACTICE RING,

1 YEAR LIMITED WARRANTY, WEIGHT: 4 LBS. GROUND COURIER SERVICE, 24 HOUR SHIP

The **REBOUND RING** is designed to develop rebounding skills, and keep ball from easily falling through basketball goal • Reduces goal from standard 18" to 10 1/2" • Attaches to any 18 goal with 3 screws • Ball falls through only on perfect shot • Goal is powdercoated to protect from environmental elements.

RB: REBOUND RING,

1 YEAR LIMITED WARRANTY, WEIGHT: 4 LBS. GROUND COURIER SERVICE, 24 HOUR SHIP



The **JUNIOR JAMMER**, is designed to convert your regulation height goal to lower heights for younger players • Fits all breakaway and stationary goals • Attaches to indoor and outdoor goals quickly and easily • Heavy duty hand knobs secure mini goal to existing goal • Lowers rim to official youth height of 8' 6" and moves goal 2' closer to foul line • The **JJ5 ADJUSTABLE JUNIOR JAMMER** is similar to the JJ1, but it can be adjusted up to 5 different fixed heights.

JJ1: JUNIOR JAMMER BACKBOARD ADAPTER, LOWERS TO 8' 6"

2 YEAR LIMITED WARRANTY, WEIGHT: 45 LBS. GROUND COURIER SERVICE, 72 HOUR SHIP

JJ5A: ADJUSTABLE JUNIOR JAMMER BACKBOARD ADAPTER, LOWERS TO 5 DIFFERENT HEIGHTS

2 YEAR LIMITED WARRANTY, WEIGHT: 50 LBS. GROUND COURIER SERVICE, 72 HOUR SHIP



INDOOR VOLLEYBALL AND NET SPORTS

Did you know that volleyball is second only to the game of soccer in popularity worldwide? For decades, those millions of passionate athletes and elite volleyball programs in the U.S. and all over the world have trusted their games to GARED's SSI Volleyball brand. Now GARED is continuing SSI's tradition of excellence and innovation with our redesigned Rallyline™ and Libero™ brands of competition and recreational indoor volleyball systems with added safety and convenience features. If you're looking for versatility, look no further than our Go Court portable units or SkyMaster ceiling-suspended system! GARED maximizes court sharing with our Sideline sand volleyball, Mongoose sand and grass volleyball, badminton, tennis, Hoopla netball, handball & futsal net sport equipment. No matter program requirements are, rely on GARED's line of premium indoor and outdoor volleyball, net sport systems, accessories, and storage equipment to take on your most demanding games!





THE SKYMASTER® ALLOWS SETTING THE NET AT YOUR FINGERTIPS • Our ceiling-suspended volleyball system eliminates the need for transporting volleyball equipment, while saving storage space • This innovative design allows you to electrically raise and lower your entire system up and out of the way of other court activities in just minutes! • Everything you need to play is included with the system, including upright pads and a premium net • Optional padded referee stand is available • The SkyMaster® can be custom-manufactured to meet the specific requirements of any facility and is available in one, two, or three-court configurations • **25 YEAR LIMITED WARRANTY ON STRUCTURE, 5 YEAR LIMITED WARRANTY ON WINCH ASSEMBLY.**

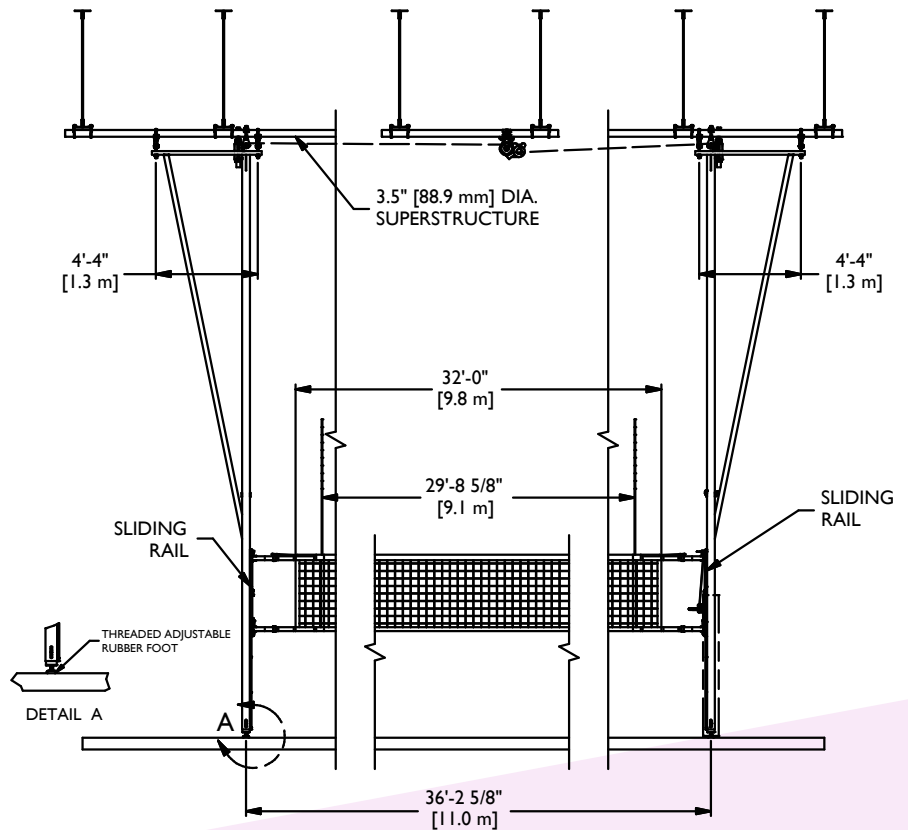

THE SKYMASTER® CEILING-SUSPENDED VOLLEYBALL SYSTEM FEATURES:

- 4" square powdercoated steel support structure
- 1HP dual drum direct drive electric hoist
- Rail system for net attachment provides infinite net height adjustment for volleyball, badminton, and tennis.
- Easy-to-operate ratchet winch with folding handle for safe adjustment
- Fully padded uprights
- Unique adjustable foot pad for added stability
- Includes antennas, sideline markers, and cable covers
- Available in 1, 2, or 3-court configurations
- SafStops for added safety

8001: SKYMASTER®, ONE-COURT VOLLEYBALL SYSTEM

WEIGHT: VARIES, TRUCK, FREIGHT CLASS 85,
6-8 WEEK SHIP AFTER FIELD DIMENSION VERIFICATION

- (1) COMPETITION NET
- (1) PAIR OF ANTENNAS AND SIDELINE MARKERS
- (2) UPRIGHT SAFETY PADS

8001R: SKYMASTER®, ONE-COURT VOLLEYBALL SYSTEM AND PADDED REFEREE STAND

WEIGHT: VARIES, TRUCK, FREIGHT CLASS 85,
6-8 WEEK SHIP AFTER FIELD DIMENSION VERIFICATION

- SAME AS ABOVE WITH PADDED REFEREE STAND

8002: SKYMASTER®, TWO-COURT VOLLEYBALL SYSTEM

WEIGHT: VARIES, TRUCK, FREIGHT CLASS 85, 6-8 WEEK SHIP AFTER FIELD DIMENSION VERIFICATION

8002R: SKYMASTER®, TWO-COURT VOLLEYBALL SYSTEM AND PADDED REFEREE STAND

WEIGHT: VARIES, TRUCK, FREIGHT CLASS 85, 6-8 WEEK SHIP AFTER FIELD DIMENSION VERIFICATION

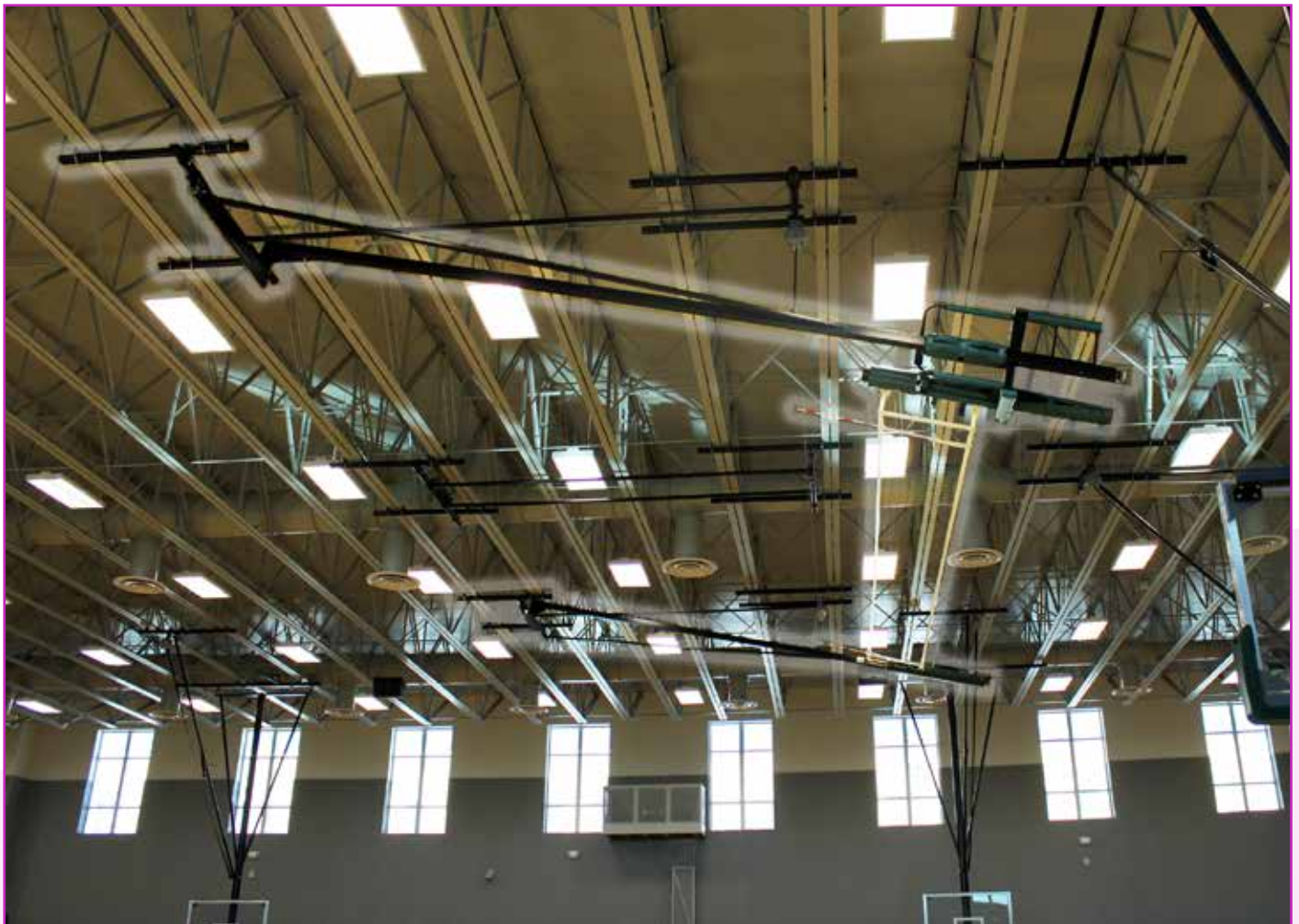
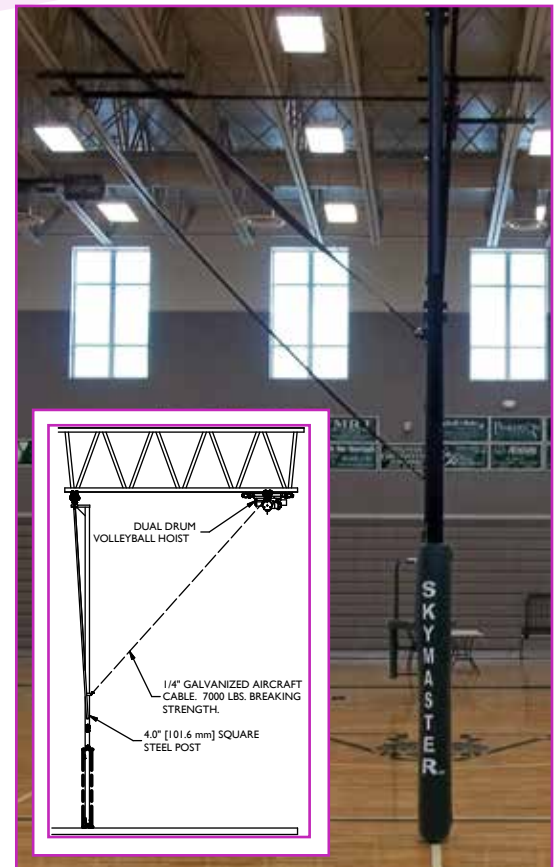



The **GO COURT®** systems are portable volleyball systems that eliminate installing sleeves into your gym floor • This innovative design allows you to easily wheel your entire system in and out of the way of other court activities in just minutes! • Everything you need to play is included with the system, including safety pads and a premium net • The padded referee stand is included as part of the system • The Go Court® can be custom-manufactured to meet the specific requirements of any facility and is available in one or two court configurations • **LIMITED LIFETIME WARRANTY ON UPRIGHTS AND PORTABLE BASE.**



8500: GO COURT®, ONE-COURT PORTABLE VOLLEYBALL SYSTEM

WEIGHT: VARIES, TRUCK, FREIGHT CLASS 85, 6-8 WEEK SHIP

- (1) Set of aluminum uprights on portable base
- (1) Competition net
- (1) Pair of antennas and sideline markers
- (2) Safety pads

8502: GO COURT®, TWO-COURT PORTABLE VOLLEYBALL SYSTEM

WEIGHT: VARIES, TRUCK, FREIGHT CLASS 85, 6-8 WEEK SHIP

- (1) Set of aluminum upright on portable base
- (2) Competition net
- (2) Pair of antennas and sideline markers
- (3) Safety pads



8535: GO COURT® JR, ONE-COURT PORTABLE VOLLEYBALL SYSTEM

WEIGHT: VARIES, TRUCK, FREIGHT CLASS 85, 6-8 WEEK SHIP

- (1) Set of 3 1/2 aluminum uprights on portable base
- (1) Competition net
- (1) Pair of antennas and sideline markers
- (2) Safety pads
- Retrofit available for 3 1/2" preexisting systems
- Must use collapsible referee stand



8535PKG-SIT: GO COURT® JR, SITTING ONE-COURT PORTABLE VOLLEYBALL SYSTEM

WEIGHT: VARIES, TRUCK, FREIGHT CLASS 85, 6-8 WEEK SHIP

- (1) Set of 3 1/2 aluminum uprights on portable base
- (1) Competition net
- (1) Pair of antennas and sideline markers
- (2) Safety pads
- Must use collapsible referee stand

8536PKG-SIT: GO COURT® JR, SITTING ONE-COURT PORTABLE VOLLEYBALL SYSTEM WITH WHEELS

WEIGHT: VARIES, TRUCK, FREIGHT CLASS 85, 6-8 WEEK SHIP

- (1) Set of 3 1/2 aluminum uprights on portable base
- (1) Competition net
- (1) Pair of antennas and sideline markers
- (2) Safety pads
- Must use collapsible referee stand

6005-ST: GO COURT® JR, SITTING POST PACKAGE

7600-SIT: GO COURT® JR, SITTING VOLLEYBALL NET

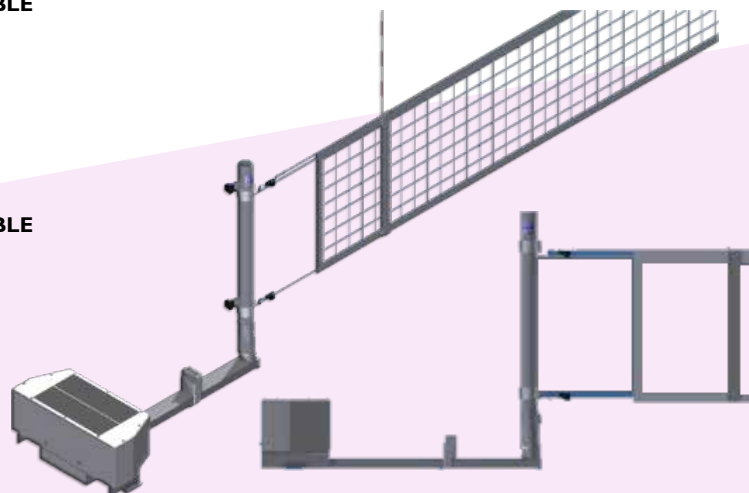



7300 LIBERO™ MASTER TELESCOPIC SYSTEM

Top-of-the-line, premium volleyball system designed for competition play • 4" O.D. telescopic uprights are constructed of a strong, yet lightweight, anodized extruded aluminum for superior support and long life • Features an internal spring assist guide which allows the telescoping posts to glide easily up or down for precise height adjustment without having to remove the net • Easy-to-operate ratchet winch sets net tension • New 3-point net attachment makes set up quick and easy • Height indicator decal includes Men's (7' 11 5/8"), Women's (7' 4 1/8"), and Junior's (7') net heights – applied in the field to your facility conditions • Exclusive wedge lock holds sliding rail system securely • One, two, and three-court systems available • Meets USVBA, NCAA, and NFHS competition specifications • **10 YEAR LIMITED WARRANTY ON POSTS AND 3 YEAR LIMITED WARRANTY ON WINCH ASSEMBLY, LOCKING RAILS, FLOOR SLEEVES AND COVERS.**

7300: MASTER TELESCOPIC ONE-COURT VOLLEYBALL SYSTEM

WEIGHT: 133 LBS (60 KGS.), TRUCK, FREIGHT CLASS 100, 48 HOUR SHIP

ONE-COURT SYSTEM INCLUDES:

- (1) 4" O.D. Master telescopic upright
- (1) 4" O.D. Master telescopic upright with winch
- (2) 4" Floor sleeves
- (2) Swivel brass or chrome cover plates
- (1) Competition net
- (1) Pair of antennas and sideline markers
- (2) Upright safety pads

7305: MASTER TELESCOPIC ONE-COURT VOLLEYBALL SYSTEM, LESS FLOOR SLEEVES AND COVERS

WEIGHT: 111 LBS (50 KGS.), TRUCK, FREIGHT CLASS 100, 48 HOUR SHIP

7302: MASTER TELESCOPIC TWO-COURT VOLLEYBALL SYSTEM,

WEIGHT: 208 LBS (95 KGS.), TRUCK, FREIGHT CLASS 100, 48 HOUR SHIP

7307: MASTER TELESCOPIC TWO-COURT VOLLEYBALL SYSTEM, LESS FLOOR SLEEVES AND COVERS

WEIGHT: 171 LBS (78 KGS.), TRUCK, FREIGHT CLASS 100, 48 HOUR SHIP

7300 SYSTEM FEATURES

1. Competition volleyball system with telescopic post
2. Telescopic design will keep net at top of post no matter what height off the floor
3. Heavy duty ratchet winch for smooth and easy net tension adjustment handle that folds for added safety
4. Cam lever with GARED'S exclusive wedge lock design holds the net securely with no "creeping"
5. Internal spring assist to easily adjust the telescopic post
6. Lightweight 4" O.D. aluminum posts with inset grooves for added strength



EASY GLIDE RAIL SYSTEM



DIRECT NETGUIDE™ ATTACHMENT SYSTEM





2

1

3

4

5

7200 LIBERO™ COLLEGIATE SYSTEM

Top-quality multi-use system features infinite net height adjustment to 8', allowing volleyball, tennis, and badminton play – ideal for multi-purpose facilities • 4" O.D. uprights are constructed of a strong, yet lightweight anodized extruded aluminum for superior support and long life • Net height is achieved by sliding the inside post rails to desired setting • Easy-to-operate ratchet winch sets net tension • New 3-point net attachment makes set up quick and easy • Height indicator decal includes Men's (7' 11 5/8"), Women's (7' 4 1/8"), and Junior's (7') net heights – applied in the field to your facility conditions • Exclusive wedge lock holds sliding rail system securely • One, two, and three-court systems available • Meets USVBA, NCAA, and NFHS competition specifications • **10 YEAR LIMITED WARRANTY ON POSTS AND 3 YEAR LIMITED WARRANTY ON WINCH ASSEMBLY, LOCKING RAILS, FLOOR SLEEVES AND COVERS.**

7200: COLLEGIATE ONE-COURT VOLLEYBALL SYSTEM
WEIGHT: 109 LBS (85 KGS.), TRUCK, FREIGHT CLASS 100, 48 HOUR SHIP

ONE-COURT SYSTEM INCLUDES:

- (1) 4" O.D. COLLEGIATE UPRIGHT
- (1) 4" O.D. COLLEGIATE UPRIGHT WITH WINCH
- (2) 4" FLOOR SLEEVES
- (2) SWIVEL BRASS OR CHROME COVER PLATES
- (1) COMPETITION NET
- (1) PAIR OF ANTENNAS AND SIDELINE MARKERS
- (2) UPRIGHT SAFETY PADS

7205: COLLEGIATE ONE-COURT VOLLEYBALL SYSTEM, LESS FLOOR SLEEVES AND COVERS
WEIGHT: 87 LBS (40 KGS.), TRUCK, FREIGHT CLASS 100, 48 HOUR SHIP

7202: COLLEGIATE TWO-COURT VOLLEYBALL SYSTEM
WEIGHT: 183 LBS (83 KGS.), TRUCK, FREIGHT CLASS 100, 48 HOUR SHIP

7207: COLLEGIATE TWO-COURT VOLLEYBALL SYSTEM, LESS FLOOR SLEEVES AND COVERS
WEIGHT: 146 LBS (66 KGS.), TRUCK, FREIGHT CLASS 100, 48 HOUR SHIP

7200 SYSTEM FEATURES

1. Multi-use system with infinite net height adjustment for volleyball, tennis, or badminton
2. Easy glide rail for quick height adjustment without ever removing the net
3. Heavy duty ratchet winch for smooth and easy net tension adjustment handle that folds for added safety
4. Cam lever with GARED'S exclusive wedge lock design holds the net securely with no "creeping"
5. Lightweight 4" O.D. aluminum posts with inset grooves for added strength



EASY GLIDE RAIL SYSTEM



4" O.D. CROSS SECTION



6100 RALLYLINE™ SCHOLASTIC TELESCOPIC SYSTEM

Best-selling competition volleyball system with quick and easy set up with preset heights utilizing our unique pin-lock mechanism • The telescopic tube raises and lowers easily with the spring assist operation for men's, women's and junior's play • Our innovative top cap allows the winch strap to move effortlessly over the post for easy to reach attachment to the net • The 3 1/2" O.D. telescopic uprights are constructed of a strong, yet lightweight anodized extruded aluminum for superior support and long life • Unique pin-lock mechanism with spring assist allows posts to adjust to Men's (7' 11 5/8"), Women's (7' 4 1/8"), and Junior's (7') net heights • Easy-to-operate ratchet winch sets net tension • New 3-point net attachment makes set up quick and easy • Bottoms of uprights feature adjustable, non-marking pads • Meets USVBA, NCAA, and NFHS competition specifications • **10 YEAR LIMITED WARRANTY ON UPRIGHTS AND 3 YEAR LIMITED WARRANTY ON WINCH ASSEMBLY, FLOOR SLEEVES AND COVERS**

6100: SCHOLASTIC TELESCOPIC ONE-COURT VOLLEYBALL SYSTEM

WEIGHT: 153 LBS (70 KGS.), TRUCK, FREIGHT CLASS 100, 48 HOUR SHIP

ONE-COURT SYSTEM INCLUDES:

- (1) 3-1/2" O.D. SCHOLASTIC TELESCOPIC UPRIGHT
- (1) 3-1/2" O.D. SCHOLASTIC TELESCOPIC UPRIGHT WITH WINCH
- (2) 3-1/2" FLOOR SLEEVES
- (2) SWIVEL BRASS OR CHROME COVER PLATES
- (1) COMPETITION NET
- (1) PAIR OF ANTENNAS AND SIDELINE MARKERS
- (2) UPRIGHT SAFETY PADS

6105: SCHOLASTIC TELESCOPIC ONE-COURT VOLLEYBALL SYSTEM, LESS FLOOR SLEEVES AND COVERS

WEIGHT: 127 LBS (58 KGS.), TRUCK, FREIGHT CLASS 100, 48 HOUR SHIP

6102: SCHOLASTIC TELESCOPIC TWO-COURT VOLLEYBALL SYSTEM, LESS SLEEVES AND COVERS

WEIGHT: 178 LBS (81 KGS.), TRUCK, FREIGHT CLASS 100, 48 HOUR SHIP

6103: SCHOLASTIC TELESCOPIC TWO-COURT VOLLEYBALL SYSTEM, LESS SLEEVES AND COVERS

WEIGHT: 152 LBS (69 KGS.), TRUCK, FREIGHT CLASS 100, 48 HOUR SHIP

6100 SYSTEM FEATURES

1. Heavy duty ratchet winch for smooth and easy net tension adjustment
2. Easy glide slide collars for infinite net height adjustment
3. Winch handle that folds for added safety
4. Lightweight high strength 3.5" O.D. aluminum post
5. Adjustable foot pad for achieving precise height requirements



DIRECT NETGUIDE™ ATTACHMENT SYSTEM



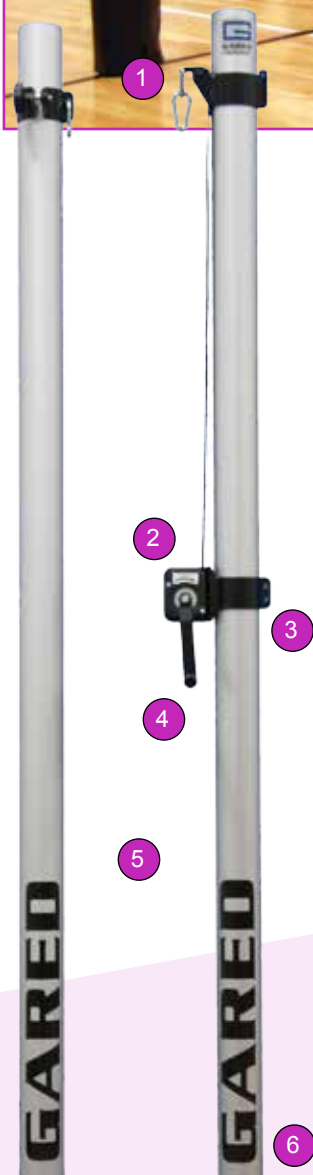

6000 RALLYLINE™ SCHOLASTIC SYSTEM

Durable and economical, designed for any size budget • Extremely versatile aluminum volleyball system offering the most complete line of net sports all within just one system • With easy to use slide collars, the net is infinitely raised and lowered from men's height to tennis and anywhere in between within a matter of minutes • Unique pin-lock mechanism allows posts to adjust to Men's (7' 11 5/8"), Women's (7' 4 1/8"), and Junior's (7') net heights • The 3 1/2" O.D. lightweight high strength aluminum post with anodized finish is designed for the facility requiring a product that will withstand years of abuse and always provide dependable performance • Bottoms of uprights feature adjustable, non-marking pads • Meets USVBA, NCAA, and NFHS competition specifications • **10 YEAR LIMITED WARRANTY ON UPRIGHTS AND 3 YEAR LIMITED WARRANTY ON WINCH ASSEMBLY, FLOOR SLEEVES AND COVERS**

6000: SCHOLASTIC ONE-COURT VOLLEYBALL SYSTEM
WEIGHT: 122 LBS (55 KGS.), TRUCK, FREIGHT CLASS 100, 48 HOUR SHIP

ONE-COURT SYSTEM INCLUDES:

- (1) 3 1/2" O.D. Scholastic upright
- (1) 3 1/2" O.D. Scholastic upright with winch
- (2) 3 1/2" floor sleeves
- (2) Swivel brass or chrome cover plates
- (1) Competition net
- (1) Pair of antennas and sideline markers
- (2) Upright safety pads

6005: SCHOLASTIC ONE-COURT VOLLEYBALL SYSTEM, LESS FLOOR SLEEVES AND COVERS
WEIGHT: 96 LBS (44 KGS.), TRUCK, FREIGHT CLASS 100, 48 HOUR SHIP

6002: SCHOLASTIC TWO-COURT VOLLEYBALL SYSTEM
WEIGHT: 199 LBS (90 KGS.), TRUCK, FREIGHT CLASS 100, 48 HOUR SHIP

6003: SCHOLASTIC TWO-COURT VOLLEYBALL SYSTEM, LESS FLOOR SLEEVES AND COVERS
WEIGHT: 175 LBS (79 KGS.), TRUCK, FREIGHT CLASS 100, 48 HOUR SHIP

6000 SYSTEM FEATURES

1. GARED'S exclusive direct NetGuide® system for hassle free set-up. No additional cables or chains required
2. Heavy duty ratchet winch for smooth and easy net tension adjustment
3. Easy glide slide collars for infinite net height adjustment
4. Winch handle that folds for added safety
5. Lightweight high strength 3.5" O.D. aluminum post
6. Adjustable foot pad for achieving precise height requirements





5100 OMNISTEEL™ SCHOLASTIC TELESCOPIC SYSTEM

Steel competition volleyball system offers a traditional design with unmatched strength for all levels of volleyball play • Durable 3" O.D. telescopic steel posts for competition regulation games provide unyielding strength and support • Sleek black powdercoated finish • Features hassle-free net height adjustment with our pin-lock mechanism designed to quickly set the net to men's, women's, and juniors heights • Engraved markings on telescopic post indicate height • Internal spring system keeps telescopic post from free falling inside the base post when the pin lock is removed • Net Glide System at the top of the post easily glides the net cable over the post to the ratchet winch for tensioning • Meets USVBA, NCAA, and NFHS competition specifications, **LIMITED LIFETIME WARRANTY ON UPRIGHTS AND 3 YEAR LIMITED WARRANTY ON WINCH ASSEMBLY, FLOOR SLEEVES AND COVERS**

5100: OMNISTEEL™ ONE-COURT VOLLEYBALL SYSTEM

WEIGHT: 186 LBS (85 KGS.), TRUCK, FREIGHT CLASS 100, 48 HOUR SHIP

ONE-COURT SYSTEM INCLUDES:

- (1) 3" O.D. Scholastic upright
- (1) 3" O.D. Scholastic upright with winch
- (2) 3" Floor sleeves
- (2) Swivel brass or chrome cover plates
- (1) Competition net
- (1) Pair of antennas and sideline markers
- (2) Upright safety pads

5105: OMNISTEEL™ ONE-COURT VOLLEYBALL SYSTEM

LESS FLOOR SLEEVES AND COVER PLATES

WEIGHT: 168 LBS (76 KGS.), TRUCK, FREIGHT CLASS 100, 48 HOUR SHIP

5102: OMNISTEEL™ TWO-COURT SYSTEM

WEIGHT: 272 LBS (124 KGS.), TRUCK, FREIGHT CLASS 100, 48 HOUR SHIP

5183: OMNISTEEL™ THREE-COURT SYSTEM

WEIGHT: 246 LBS (112 KGS.), TRUCK, FREIGHT CLASS 100, 48 HOUR SHIP

5100 SYSTEM FEATURES

1. Engraved height settings on each post
2. Stop pin for fast adjustment of net height
3. Cable holds pin securely to post
4. Heavy duty ratchet winch for smooth and easy net tension adjustment
5. Winch handle that folds for added safety
6. Internal spring assist for easy net height adjustment
7. 3" O.D. Steel uprights
8. Adjustable foot pad for achieving precise height requirements



HASSLE FREE NET HEIGHT ADJUSTMENT PIN LOCK SYSTEM



RATCHET WINCH WITH FOLDING HANDLE

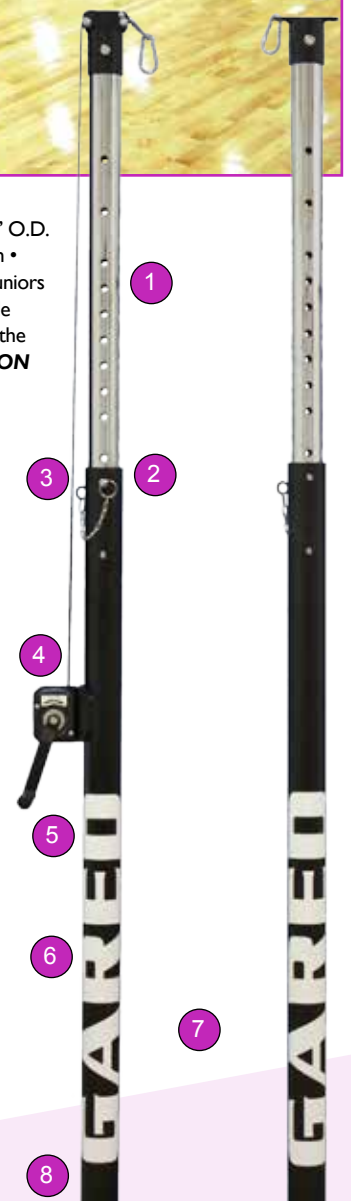



2

5000 LIBERO™ OMNI-ALUMINUM SYSTEM

Top-quality multi-use system • Features infinite net height adjustment to 8', allowing volleyball, tennis, and badminton play – ideal for multi-purpose facilities • 3" O.D. Uprights are constructed of a strong, yet lightweight anodized extruded aluminum for superior support and long life • Net height is achieved by sliding the inside post rails to desired setting • Easy-to-operate ratchet winch sets net tension • New 3-point net attachment makes set up quick and easy • Height indicator decal includes Men's (7' 11 5/8"), Women's (7' 4 1/8"), and Junior's (7") net heights – applied in the field to your facility conditions • Exclusive wedge lock holds sliding rail system securely • One, two, and three-court systems available • Meets USVBA, NCAA, and NFHS competition specifications • **10 YEAR LIMITED WARRANTY ON POSTS AND 3 YEAR LIMITED WARRANTY ON WINCH ASSEMBLY, LOCKING RAILS, FLOOR SLEEVES AND COVERS.**

1

5000: COLLEGIATE ONE-COURT VOLLEYBALL SYSTEM

WEIGHT: 109 LBS (85 KGS.), TRUCK, FREIGHT CLASS 100, 48 HOUR SHIP

ONE-COURT SYSTEM INCLUDES:

- (1) 3" O.D. collegiate upright
- (1) 3" O.D. collegiate upright with winch
- (2) 3" Floor sleeves
- (2) Swivel brass or chrome cover plates
- (1) Competition net
- (1) Pair of antennas and sideline markers
- (2) Upright safety pads

3

4

5005: COLLEGIATE ONE-COURT VOLLEYBALL SYSTEM, LESS FLOOR SLEEVES AND COVERS

WEIGHT: 87 LBS (40 KGS.), TRUCK, FREIGHT CLASS 100, 48 HOUR SHIP

5

5002: COLLEGIATE TWO-COURT VOLLEYBALL SYSTEM

WEIGHT: 183 LBS (83 KGS.), TRUCK, FREIGHT CLASS 100, 48 HOUR SHIP

5007: COLLEGIATE TWO-COURT VOLLEYBALL SYSTEM, LESS FLOOR SLEEVES AND COVERS

WEIGHT: 146 LBS (66 KGS.) TRUCK, FREIGHT CLASS 100, 48 HOUR SHIP

5000 SYSTEM FEATURES

1. Multi-use system with infinite net height adjustment for volleyball, tennis, or badminton
2. Easy glide rail for quick height adjustment without ever removing the net
3. Heavy duty ratchet winch for smooth and easy net tension adjustment handle that folds for added safety
4. Cam lever with GARED'S exclusive wedge lock design holds the net securely with no "creeping"
5. Lightweight 3" O.D. aluminum posts with inset grooves for added strength





SIDEOUT™ OUTDOOR VOLLEYBALL SYSTEM

GARED OUTDOOR VOLLEYBALL STANDARDS provide a rugged volleyball system that's ideal for recreational use as well as tournament or league play • Perfect volleyball set-up for parks, school yards, beaches, and campgrounds • Available in your choice of standard 2-3/8" O.D. or heavy-duty 3-1/2" O.D. galvanized steel posts • Uprights are 10' in total length, with 20" in ground for maximum stability • Posts are pre-drilled for volleyball and badminton net heights • Ground sleeves and caps are included to allow posts to be removed from court when not in use • Includes winch and all appropriate hardware • Model 6827 locking cover can be purchased as an upgrade to further prevent theft or tampering with sleeve covers • Posts sold in pairs; net sold separately.

ODVB: 2-3/8" OUTDOOR VOLLEYBALL STANDARDS

1 YEAR LIMITED WARRANTY ON STANDARDS

WEIGHT: 67 LBS/PR, TRUCK, FREIGHT CLASS 70, 24 HOUR SHIP

ODVB35: 3-1/2" OUTDOOR VOLLEYBALL STANDARDS

2 YEAR LIMITED WARRANTY ON STANDARDS

WEIGHT: 106 LBS/PR, TRUCK, FREIGHT CLASS 70, 24 HOUR SHIP

6827: LOCKING COVER FOR 2-3/8" VOLLEYBALL GROUND SLEEVES

WEIGHT: 1 LB/EA, GROUND COURIER SERVICE, 24 HOUR SHIP

PREMIUM OUTDOOR VOLLEYBALL NET is designed for use with ODVB, ODVB35, and ODVB40SQ standards • Constructed of 2 mm twisted polyethylene for maximum strength • Net is 28' long x 3' wide • Net headband is 19 oz x 2" heavy-duty white vinyl for ultimate outdoor protection • Side and bottom of net is taped vinyl-coated nylon • Net cable is 40' long and features a 5 mm coated steel cable top • Nets sold in eases; posts sold separately.

ODVBNET: OUTDOOR VOLLEYBALL NET, 28' X 3', 2 MM POLYETHYLENE

WEIGHT: 5 LBS/EA, GROUND COURIER SERVICE, 24 HOUR SHIP



ODVB35

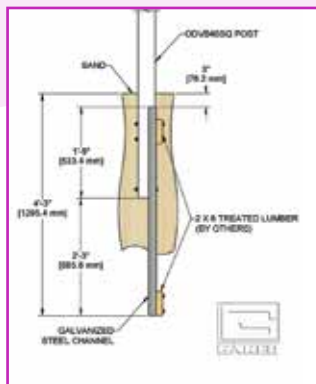

GARED OUTDOOR VOLLEYBALL SQUARE STANDARDS are constructed of high strength lightweight square aluminum extrusion with a structural channel running the length of the posts for durability and easy set-up and take-down

- Easy and quick infinite height adjustment without removing the net
- Heavy duty galvanized ratchet winch for smooth net tension
- Ideal for sand/beach volleyball championship play
- Parts for converting standards to sand play are sold separately
- Net, sleeves and covers are sold separately.

ODVB40SQ: 4" SQUARE OUTDOOR VOLLEYBALL STANDARDS
 2 YEAR LIMITED WARRANTY ON STANDARDS
 WEIGHT: 49 LBS/PR, GROUND COURIER, 24 HOUR SHIP

ODVB40SQ ACCESSORIES:

6815: CONVERSION KIT FOR ODVB40SQ BEACH VOLLEYBALL
 1 YEAR LIMITED WARRANTY, WEIGHT: 57 LBS/EA,
 GROUND COURIER, 24 HOUR SHIP

6828: 4" SQUARE SLEEVE FOR ODVB40SQ
 1 YEAR LIMITED WARRANTY. WEIGHT: 34 LBS./PAIR,
 GROUND COURIER, 24 HOUR SHIP

6829: CAP, 4" SQUARE FOR 6828 SLEEVE
 1 YEAR LIMITED WARRANTY, WEIGHT: 6 LBS./PAIR, GROUND COURIER, 24 HOUR SHIP



THE MONGOOSE® IS ON THE LOOSE!

GARED'S MONGOOSE® & LT WIRELESS VOLLEYBALL SYSTEM are the most innovative portable volleyball systems on the market today! • They are versatile and portable for play in grass, sand, or indoors, making it ideal for institutional as well residential use • With its exclusive tension-operated design and patented two-stake inground plate system, the two Mongoose systems are sturdy and durable for all levels of play, and there are no dangerous guy wires for players to trip over • Constructed of high-strength telescopic aluminum poles for long life in outdoor settings • Poles can be easily adjusted for Men's, Women's, and Junior's heights by loosening the net, easily adjusting the pole pins, and then re-tightening the net • Durable protective post padding included to protect players from injury • Installation is quick and easy and requires only a 6-LB hammer (not included).



7900: MONGOOSE® WIRELESS VOLLEYBALL SYSTEM

WEIGHT: 53 LBS, GROUND COURIER SERVICE, 24 HOUR SHIP

- (2) Adjustable high-strength anodized aluminum posts
- (2) Steel ground plates
- (2) Sand wedge adapters for beach play
- (1) Premium regulation size net
- (1) Court boundary line marker
- (2) Blue protective pole pads
- Black nylon carrying bag
- Indoor conversion sleeves available for order



7700: MONGOOSE® LT WIRELESS VOLLEYBALL SYSTEM

WEIGHT: 31 LBS, GROUND COURIER SERVICE, 24 HOUR SHIP

- (2) Adjustable high-strength anodized aluminum posts
- (2) Steel ground plates
- (1) Premium regulation size net
- (1) Court boundary line marker
- (2) Black protective pole pads
- Black nylon carrying bag



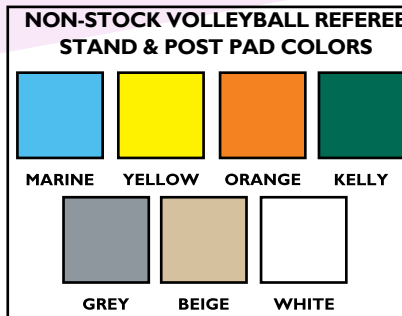

VOLLEYBALL UPRIGHT SAFETY PADDING

VOLLEYBALL UPRIGHT SAFETY PADDING protects players from injury during play • 6' high pads are comprised of 1 1/4" thick urethane foam covered in 14-oz. vinyl-coated nylon • See color chart for color availability • Meets NCAA, NFHS, and International specifications.

6010: VOLLEYBALL UPRIGHT SAFETY PAD (SPECIFY COLOR)

10 YEAR LIMITED WARRANTY, WEIGHT: 8 LBS (4 KGS.), GROUND COURIER SERVICE, 24 HOUR SHIP, FOR STOCK COLORS

6020: VOLLEYBALL CENTER UPRIGHT SAFETY PAD (SPECIFY COLOR)

10 YEAR LIMITED WARRANTY, WEIGHT: 8 LBS (4 KGS.), GROUND COURIER SERVICE, 24 HOUR SHIP FOR STOCK COLORS



6446 WITH 6040 PADS



6446 WITH 6040SQ PADS BACK AND FRONT

REFEREE STANDS AND PADDING

Our versatile **REFEREE PLATFORM** is designed for use with any system and will function as fixed or free standing • Each platform is shipped with "V" brackets (not shown) to attach directly to your post (via Velcro® straps) and an extra set of sturdy legs should you prefer the platform to be free standing • Legs are fully height adjustable and bottoms have protective end caps • Two non-marring wheels allow easy transport to and from storage area • Durable white powdercoat finish • Optional safety padding available.

6448: COLLAPSIBLE REFEREE STAND

1 YEAR LIMITED WARRANTY, WEIGHT: 68 LBS (31 KGS.), GROUND COURIER SERVICE, 24 HOUR SHIP (FOR STOCK COLORS)

REFEREE STAND SAFETY PADDING is constructed of dense foam covered with reinforced vinyl to provide maximum protection • Velcro® attachment allows for quick and easy set up • See color chart for color availability • Meets NCAA, NFHS, and International specifications.

6040: REFEREE STAND SAFETY PAD

1 YEAR LIMITED WARRANTY, WEIGHT: 12 LBS (5 KGS.), GROUND COURIER SERVICE, 24 HOUR SHIP (FOR STOCK COLORS)



FLOOR SLEEVE AND COVER

VOLLEYBALL FLOOR SLEEVES are constructed of heavy-gauge steel for increased support of volleyball uprights in indoor facilities • Allow uprights to be removed and stored out of the way of other court activities • Designed for use with floating and non-floating synthetic floors • Choose 4", 3 1/2", or 3" inside diameter, depending on your facility's requirements.

6405: 4" O.D. X 12" DEEP FLOOR SLEEVE

WEIGHT: 7 LBS (3 KGS.), GROUND COURIER SERVICE, 24 HOUR SHIP

6400: 3 1/2" O.D. X 10" DEEP FLOOR SLEEVE

WEIGHT: 8 LBS (4 KGS.), GROUND COURIER SERVICE, 24 HOUR SHIP

6404: 3" O.D. X 9" DEEP FLOOR SLEEVE

WEIGHT: 6 LBS (3 KGS.), GROUND COURIER SERVICE, 24 HOUR SHIP

COVER PLATES are constructed of a durable brass or chrome alloy with a concealed hinge for covering existing floor sleeves • All attachment screws are concealed when cover plate is in closed position, allowing for a completely flat and safe playing surface • Standard cover plates have a 5" O.D. with a total diameter of 6 1/4" • Oversized cover plates have a 6 5/8" O.D. with a total diameter of 8" • Please reference chart for cover plate size and finish.

COVER PLATES, SEE CHART FOR WEIGHTS, GROUND COURIER SERVICE, 24 HOUR SHIP

MODEL#	TOTAL DIAMETER	INSIDE DIAMETER	FINISH	SWIVEL	LOCK	WEIGHT (LBS)	WEIGHT (KGS)
6430	6 1/4"	5"	Brass	Yes	Yes	3	1
6431	6 1/4"	5"	Chrome	Yes	Yes	3	1
6423	6 1/4"	5"	Brass	No	No	4	2
6429	6 1/4"	5"	Brass	No	Yes	4	2
6426	6 1/4"	5"	Chrome	No	No	4	2
6428	6 1/4"	5"	Chrome	No	Yes	4	2
6432	8"	6 5/8"	Brass	Yes	Yes	4	2
6433	8"	6 5/8"	Chrome	Yes	Yes	4	2
6424	8"	6 5/8"	Brass	No	No	6	3
6422	8"	6 5/8"	Brass	No	Yes	6	3
6427	8"	6 5/8"	Chrome	No	No	6	3
6425	8"	6 5/8"	Chrome	No	Yes	6	3



FLOOR ANCHORS allow installation of above floor sleeves for existing facilities where access or floor structure is not ideal for installation of in ground floor sleeves • Anchors are installed flush with top of playing surface to allow for safe play • Choose from four anchor types, depending on the type of specialty flooring of your facility.

FLOOR ANCHORS, SEE CHART FOR WEIGHTS, GROUND COURIER SERVICE, 24 HOUR SHIP

MODEL#	STYLE	FLOOR TYPE APPLICATION	WEIGHT (LBS)	WEIGHT (KGS)
1015-12-00	Style B	Wood over concrete	1	.5
1026-12-00	Style BX	3 1/4" Anchor wood over concrete	1	.5
1020-12-00	Style C	Concrete or synthetic	1	.5
9112	Style E	Wood resting on sleeper or metal clip	1	.5

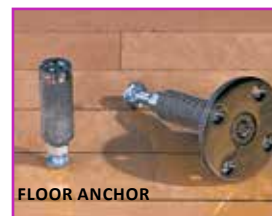

ABOVE FLOOR SLEEVES are used with floor anchors when floor will not accept traditional in ground floor sleeves • T-type base provides superior support and eliminates the need for dangerous cables or rigid supports • Anchor included; choose from four floor anchors styles • Compatible with all GARED volleyball systems.

ABOVE FLOOR SLEEVES, SEE CHART FOR WEIGHTS, GROUND COURIER SERVICE, 24 HOUR SHIP

MODEL#	TOTAL DIAMETER	PLACEMENT	WEIGHT (LBS)	WEIGHT (KGS)
6414	3"	End Base	26	12
6406	3 1/2"	End Base	26	12
6407	4"	End Base	26	12
6050	N/A	End Base Pad	8	4
6415	3"	Center Base	18	8
6411	3 1/2"	Center Base	18	8
6408	4"	Center Base	18	8
6060	N/A	Center Base Pad	8	4



ABOVE FLOOR SLEEVE

BOLT-ON SECOND STORY FLOOR SLEEVE ADAPTER allows for standard floor sleeves on every level of your facility • Unit bolts to underside of concrete or beam and allows for normal installation of floor sleeves • Constructed of 6 5/8" O.D. heavy-gauge steel and .156 wall tubing and steel channels for ultimate support and stability • Adapter measures 6" O.D. and is for use with all sleeves • Compatible with all GARED volleyball systems.

CUSTOM BASE ADAPTERS allow your facility to upgrade to GARED volleyball systems without the added expense of replacing your existing floor sleeves • Custom-designed to retrofit virtually any floor sleeve • Specify the diameter and depth of your existing floor sleeve when ordering.

SLEEVE AND BASE ADAPTER, SEE CHART FOR WEIGHTS, GROUND COURIER SERVICE, 24 HOUR SHIP

MODEL#	TOTAL DIAMETER	ADAPTER PLACEMENT	WEIGHT (LBS)	WEIGHT (KGS)
6401	6"	Second Story Sleeve Adapter	29	13
6283	3"	Custom Base Adapter	8	4
6284	3 1/2"	Custom Base Adapter	8	4
6289	Custom	Custom Base Adapter	8	4





7600 COMPETITION NET

2 1/2" wide **SIDELINE MARKERS** are constructed of heavy-duty 18-oz. vinyl and fasten easily to the net with Velcro® attachments

- Each sideline marker includes a full-length pocket to insert antenna and is sold in pairs only
- Antennas are 72" long x 3/8" O.D. solid fiberglass rods with alternating 4" bands of red and white striping on top half
- Bottoms of antennas feature rounded edges to prevent snagging or tearing of sideline marker
- Antennas are sold in pairs only and can be used separately or with sideline markers.

6410: NET ANTENNA AND SIDELINE MARKER COMBO (INCLUDES A PAIR OF EACH)

WEIGHT: 4 LBS/SET (2 KGS.), GROUND COURIER SERVICE, 24 HOUR SHIP

6412: NET ANTENNAS ONLY, 1 PAIR

WEIGHT: 2 LBS/PR (2 KGS.), GROUND COURIER SERVICE, 24 HOUR SHIP

6413: SIDELINE MARKERS ONLY, 1 PAIR

WEIGHT: 2 LBS/PR (2 KGS.), GROUND COURIER SERVICE, 24 HOUR SHIP

VBNB: SCHOOL SPIRIT NET BAND, 1 NET

WEIGHT: 2 LBS/PR (2 KGS.), GROUND COURIER SERVICE, 24 HOUR SHIP



6410



SPIRIT NET BAND



BR-16



BR-12

COMPETITION VOLLEYBALL NETS

Our **COMPETITION VOLLEYBALL NETS** are constructed of quality materials designed for quick and easy set-up

- Features a fully enclosed fiberglass dowel and 4" square #36 nylon mesh for superior performance and durability
- Free floating net along a 1/8" steel cable allows for easy centering of the net above the court lines
- Extremely strong Velcro® straps work with a "D" ring design to tighten the net and hold until released
- All nets are covered by 1 year limited warranty.

7600: COMPETITION NET FOR USE WITH GARED NET GUIDE™ SYSTEMS

PLEASE IDENTIFY YOUR CURRENT VOLLEYBALL SYSTEM MODEL
WEIGHT: 10 LB (5 KG.), GROUND COURIER SERVICE, 24 HOUR SHIP

7610: CUSTOM LENGTH VOLLEYBALL NET, MAX LENGTH IS 40'

WEIGHT: VARIES, GROUND COURIER SERVICE, 24 HOUR SHIP

NET CABLE COVERS are made of heavy-duty vinyl with Velcro® attachments to ensure maximum player safety

- Designed to be easily fitted to exact conditions
- Sold in sets of four.

6251: NET CABLE COVERS, SET OF FOUR

WEIGHT: 1 LB (.5 KG.), GROUND COURIER SERVICE, 24 HOUR SHIP

STURDY VOLLEYBALL BALL RACKS are constructed of 1" O.D., 18-gauge chrome-plated steel tubing to provide rust protection and a bright appearance

- 4-tier rack holds up to 16 volleyballs; 3-tier rack holds up to 12 volleyballs
- Four 2" hardened rubber swivel casters are non-marring and will not damage hardwood or synthetic floors.

BR-16: 4-TIER BALL RACK, 16 BALL CAPACITY

1 YEAR LIMITED WARRANTY, WEIGHT: 18 LBS (8 KGS.), GROUND COURIER SERVICE, 24 HOUR SHIP

BR-12: 3-TIER BALL RACK, 12 BALL CAPACITY

1 YEAR LIMITED WARRANTY, WEIGHT: 14 LBS (6 KGS.), GROUND COURIER SERVICE, 24 HOUR SHIP

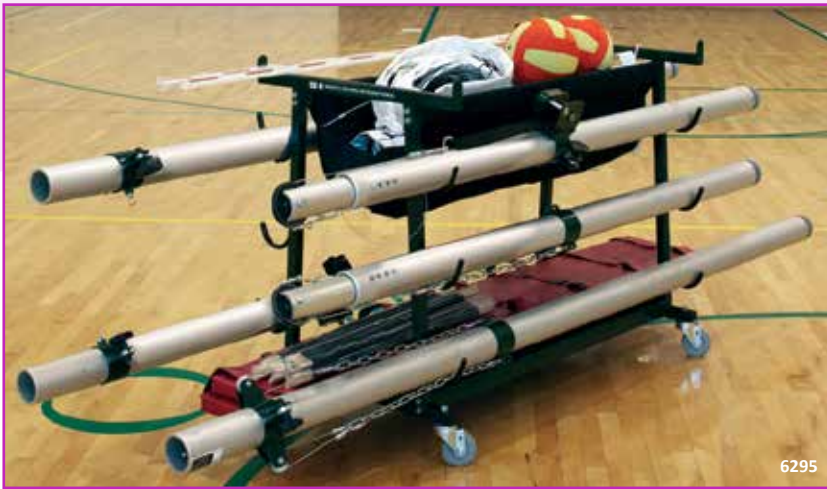

6295

VOLLEYBALL EQUIPMENT STORAGE CART will quickly and easily store your entire volleyball system with our equipment storage cart • This handy cart stores up to six volleyball uprights, referee stand and pads • The convenient basket also holds net, antennas and balls • The non-marring casters roll easily to store your entire system in your storage area in one trip.

6295: VOLLEYBALL EQUIPMENT STORAGE CART
WEIGHT: 70 LBS (32 KGS.), GROUND COURIER SERVICE, 24 HOUR SHIP

VOLLEYBALL UPRIGHT TRANSPORTER allows for easy portability of volleyball posts • Compact steel cup transports one upright at a time into storage area.

6290: VOLLEYBALL UPRIGHT TRANSPORTER, 3"
WEIGHT: 5 LBS (2 KGS.), GROUND COURIER SERVICE, 24 HOUR SHIP

6294: VOLLEYBALL UPRIGHT TRANSPORTER, 3 1/2"
WEIGHT: 5 LBS (2 KGS.), GROUND COURIER SERVICE, 24 HOUR SHIP

6293: VOLLEYBALL UPRIGHT TRANSPORTER, 4"
WEIGHT: 5 LBS (2 KGS.), GROUND COURIER SERVICE, 24 HOUR SHIP



6290



6291

VOLLEYBALL UPRIGHT STORAGE BRACKETS save valuable floor space when system is not in use • Holds a pair of uprights either vertically or horizontally on any wall.

6291: VERTICAL UPRIGHT STORAGE BRACKET
WEIGHT: 3 LBS (2 KGS.), GROUND COURIER SERVICE, 24 HOUR SHIP

6292: HORIZONTAL UPRIGHT STORAGE BRACKET
WEIGHT: 7 LBS (3 KGS.), GROUND COURIER SERVICE, 24 HOUR SHIP



6292



STORE-IT STORAGE RACKS are freestanding movable trolleys which easily and neatly store volleyball nets while using minimal floor space • Constructed of steel with a black powdercoat finish for long-lasting durability • Non-marring castors allow multi-directional movement of unit • Available for single, double, or triple net capacity.

9930: STORE-IT, SINGLE NET STORAGE RACK
WEIGHT: 30 LBS (14 KGS.), GROUND COURIER SERVICE, 24 HOUR SHIP

9940: SUPER STORE-IT, DOUBLE NET STORAGE RACK
WEIGHT: 35 LBS (16 KGS.), GROUND COURIER SERVICE, 24 HOUR SHIP

9933: SUPER STORE-IT, TRIPLE NET STORAGE RACK
WEIGHT: 40 LBS (18 KGS.), GROUND COURIER SERVICE, 24 HOUR SHIP



INDOOR & OUTDOOR NET SPORTS

Are you looking for badminton, tennis, or tetherball equipment for your school, park, or recreation facility? Look no further than GARED! Check out our exceptional outdoor volleyball equipment selection, engineered and manufactured to the same high standards as our world-class indoor line! Our premium net sport products are built to last for even the roughest play environments! GARED has everything your organization needs to keep up with the latest innovations for these ever-popular sports - from posts and nets, to all the extras such as ground sleeves, anchors, locking covers, and more!



INDOOR BADMINTON

SLEEVE-TYPE BADMINTON SYSTEM is ideal for competition or recreational use • Constructed of 1 1/2" square steel-tubed uprights • Powdercoated white for durability and long life • Designed to be installed into permanent floor sleeves for easy removal when not in use • Includes adjustable foot pad to gain accurate net height.

6619: ONE-COURT SLEEVE-TYPE BADMINTON SYSTEM

1 YEAR LIMITED WARRANTY, WEIGHT: 40 LBS (18 KGS.), TRUCK, FREIGHT CLASS 85, 48 HOUR SHIP

ONE-COURT BADMINTON SYSTEM INCLUDES:

- (2) 1 1/2" square badminton uprights
- (2) 1 1/2" square floor sleeves
- (2) Swivel brass cover plates
- (1) Badminton net

6617: SLEEVE-TYPE BADMINTON UPRIGHT

6618: SLEEVE-TYPE BADMINTON CENTER UPRIGHT

6620: BADMINTON NET, 21' X 2' 6"



PORTABLE BADMINTON SYSTEM is an economical and versatile alternative to sleeve-type badminton systems • Constructed of 1 1/2" square steel-tubed uprights • Powdercoated white for durability and long life • Weighted base with T-bar keeps posts rigidly in place • Solid rubber castors allow quick and easy transport in and out of storage area • Center uprights available for multi-court configurations.

6631: ONE-COURT PORTABLE BADMINTON SYSTEM WITH 60LB BASE

1 YEAR LIMITED WARRANTY, WEIGHT: 150 LBS (68 KGS.), TRUCK, FREIGHT CLASS 85, 48 HOUR SHIP

ONE-COURT PORTABLE BADMINTON SYSTEM INCLUDES:

- (2) Portable badminton uprights with weighted t-bar
- (1) Badminton net

6630: PORTABLE BADMINTON UPRIGHT

6632: PORTABLE BADMINTON CENTER UPRIGHT

6620: BADMINTON NET, 21' X 2' 6"

HEAVY DUTY INTERNATIONAL PORTABLE BADMINTON SYSTEM INCLUDES:

- (2) Portable badminton uprights with weighted t-bar
- (1) Badminton net

6635: ONE-COURT PORTABLE SQUARE BADMINTON SYSTEM WITH 120 LB BASE

1 YEAR LIMITED WARRANTY, WEIGHT: 270 LBS (169 KGS.), GROUND COURIER SERVICE, 24 HOUR SHIP

6640: ONE-COURT PORTABLE ROUND BADMINTON SYSTEM WITH 120 LB BASE

1 YEAR LIMITED WARRANTY, WEIGHT: 270 LBS (169 KGS.), GROUND COURIER SERVICE, 24 HOUR SHIP

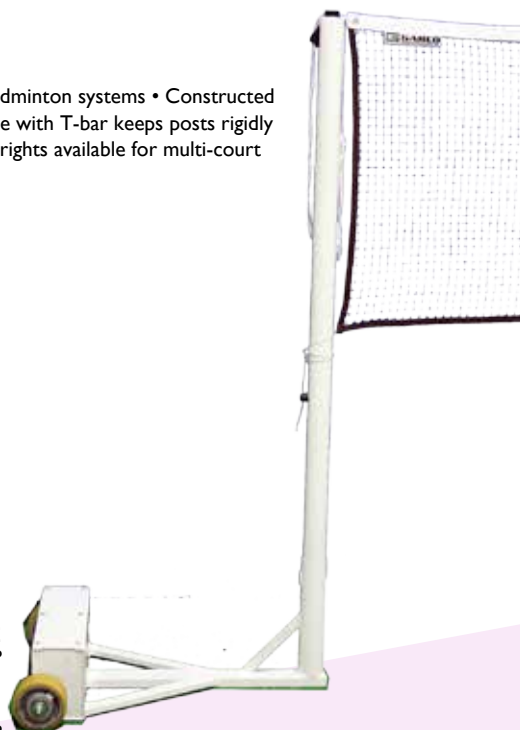

GARED has all the equipment you need for one of the fastest growing sports worldwide – NETBALL! • We carry a large assortment of Netball Systems, whether you're playing in an official league, or just want an economical system for your backyard • Choose from our steel or aluminum systems, with either portability or inground mounting to fit your specific needs • Netball systems include an orange powdercoated rim with 15" diameter for official play, along with post, net, and hardware • Portable systems include a base for easy transport of unit • Some systems not shown in catalog - visit WWW.GAREDSPORTS.COM for our complete selection of premium **HOOPLA™ NETBALL EQUIPMENT**.

8415: RECREATIONAL PORTABLE HOOPLA™ NETBALL SYSTEM

- 1 YEAR WARRANTY, WEIGHT: 28 LBS (13 KGS.), GROUND COURIER SERVICE, 24 HOUR SHIP
- Telescopic post allows rim to easily adjust to 8 ft, 9 ft, and 10 ft heights
 - Post is 2" O.D., 10' tall
 - Post is constructed of steel and powdercoated white for maximum protection and longer life
 - Plastic base measures 33 1/2" x 22" x 6 1/2"
 - Base can be filled with water or sand (not included) for stability of unit
 - System includes wheels on the base for easy mobility
 - Complete system includes (1) base, (1) post, (1) rim and (1) net
 - Designed for home and recreational use

8412: STEEL PORTABLE HOOPLA™ NETBALL SYSTEM WITH STEEL BASE

- 5-YEAR WARRANTY, WEIGHT: 114 LBS (51 KGS.), GROUND COURIER SERVICE, 24 HOUR SHIP
- Rim can be adjusted to 8', 9', or 10' by bolting into pre-drilled holes on post
 - Post is 2-1/2" O.D. and 10' tall
 - Post is constructed of steel and powdercoated white for maximum protection and longer life
 - Triangular steel base measures 28" L x 24" W and weighs 55 lbs to stabilize unit
 - Base is powdercoated black
 - Complete system includes (1) base, (1) post, (1) rim and (1) net
 - Designed for league and tournament use

8432: ALUMINUM PORTABLE HOOPLA™ NETBALL SYSTEM WITH STEEL BASE

- 5-YEAR WARRANTY, WEIGHT: 114 LBS (51 KGS.), GROUND COURIER SERVICE, 24 HOUR SHIP
- Rim can be adjusted to 8', 9', or 10' by bolting into pre-drilled holes on post
 - Post is 3" O.D. x 10' tall
 - Post is constructed of steel and powdercoated white for maximum protection and longer life
 - Triangular steel base measures 28" L x 24" W and weighs 55 lbs to stabilize unit
 - Base is powdercoated black
 - Complete system includes (1) base, (1) post, (1) rim and (1) net
 - Designed for league and tournament use



The **8200 OFFICIAL TEAM HANDBALL GOAL** meets all IHF Official Team Handball specifications • It is constructed of 3" (8 cm) square extruded aluminum frame with large safety radius on all corners • The 2 m x 3 m frame is supported by 1 m deep 1 5/8" (41.28 m) O.D. • Galvanized steel backstays with the lower horizontal section being rubber padded for floor protection • It features our easy connect net attachment and portable sand bags for ballast (sand is not included) • Standard finish is black powdercoat with white stripes • Used with the 8305 Official Team Handball Goal braided white net • Nets are sold separately • Handball goals are sold in pairs • **OPTIONAL EQUIPMENT: 8340: INDOOR FLOOR ANCHOR**

8200: OFFICIAL TEAM HANDBALL GOAL,
2 YEAR LIMITED WARRANTY. WEIGHT: 214 LBS/PAIR (99 KGS.),
TRUCK, FREIGHT CLASS 70, 48 HOUR SHIP

8305: OFFICIAL TEAM HANDBALL GOAL NET,
WEIGHT: 18 LBS/PAIR (8 KGS.), GROUND COURIER SERVICE, 24 HOUR SHIP



The **8300 OFFICIAL FUTSAL GOAL** meets all FIFA and US Futsal specifications • Goal is made of a 3" (8 cm) square extruded aluminum frame with large safety radius on all corners • The 2 m x 3 m frame is supported by 1 m deep 1 5/8" (41.28 m) O.D. • Galvanized steel backstays and rear stabilizing bar • It features our easy connect net attachment • Standard finish is white powdercoat • Used with the 8305 Official Futsal Goal braided white net • Nets are sold separately • Futsal goals are sold in pairs • GARED is an official partner of US Futsal • **OPTIONAL EQUIPMENT: 8340: INDOOR FLOOR ANCHOR**

8300: OFFICIAL FUTSAL GOAL,
2 YEAR LIMITED WARRANTY.
WEIGHT: 214 LBS/PAIR (99 KGS.), TRUCK, FREIGHT CLASS 70, 48 HOUR SHIP

8305: OFFICIAL FUTSAL GOAL NET,
WEIGHT: 18 LBS/PAIR (8 KGS.), GROUND COURIER SERVICE, 24 HOUR SHIP



TENNIS

DELUXE INDOOR ALUMINUM TENNIS SYSTEM is a smaller version of the GARED® volleyball system and is ideal for multi-sport facilities • 4" O.D. uprights are constructed of a strong, yet lightweight anodized extruded aluminum for superior support and long life • Easy-to-operate ratchet winch sets net tension • Exclusive wedge lock holds sliding rail system securely • Use GSTNET30LS tennis net; net sold separately.

6450: DELUXE INDOOR TENNIS SYSTEM,

1 YEAR LIMITED WARRANTY ON POSTS, WEIGHT: 55 LBS, GROUND COURIER SERVICE, 48 HOUR SHIP

ONE-COURT INDOOR TENNIS SYSTEM INCLUDES:

- (1) 4" O.D. tennis upright
- (1) 4" O.D. tennis upright with winch
- (2) 4" Floor sleeves
- (2) Hinged brass cover plates

GSTNET30LS: DELUXE INDOOR PROFESSIONAL TENNIS NET

1 YEAR LIMITED WARRANTY, WEIGHT: 22 LBS, GROUND COURIER SERVICE, 48 HOUR SHIP

6455: DELUXE INDOOR ALUMINUM TENNIS UPRIGHT

6460: DELUXE INDOOR ALUMINUM TENNIS UPRIGHT WITH WINCH

6458: DELUXE INDOOR ALUMINUM TENNIS CENTER UPRIGHT

Build a tennis court fit for the pros with **GARED® HEAVY-DUTY STEEL TENNIS POSTS** • Superior post strength and attractive design make these posts an excellent choice for competition or recreational matches • Constructed from 3" round tubular steel with integral lacing bars • Polyester powdercoated for protection against weather conditions • Includes premium brass winder • Your choice of classic green or black posts • For permanent installation, with optional ground sleeves available • Posts sold in pairs; nets sold separately • **ALL TENNIS STANDARDS ARE COVERED BY A 1 YEAR LIMITED WARRANTY.**

GSTNPERD: 3" ROUND COMPETITION TENNIS POSTS, GREEN

WEIGHT: 72 LBS/PR, GROUND COURIER SERVICE, 48 HOUR SHIP

- 3" Round tubular steel with integral lacing bars
- Green powdercoat finish

GSTNPERDB: 3" ROUND COMPETITION TENNIS POSTS, BLACK

WEIGHT: 72 LBS/PR, GROUND COURIER SERVICE, 48 HOUR SHIP

- 3" Round tubular steel with integral lacing bars
- Black powdercoat finish

GSTNPESQG3: 3" SQUARE CHAMPIONSHIP TENNIS POSTS, GREEN

WEIGHT: 86 LBS/PR, GROUND COURIER SERVICE, 48 HOUR SHIP

- 3" Square box-section steel
- Green powdercoat finish

GSTNPESQB3: 3" SQUARE CHAMPIONSHIP TENNIS POSTS, BLACK

WEIGHT: 86 LBS/PR, GROUND COURIER SERVICE, 48 HOUR SHIP

- 3" Square box-section steel
- Black powdercoat finish



GSTNPESQG3



GSTNPERDB

ECONOMICAL EXTERNAL RATCHET TENNIS POSTS provide a budget-friendly alternative to classic-style posts • Constructed from 2 7/8" heavy-duty steel and includes ratchet caps and pulley • Safety ratchet has detachable handle and sturdy hooks for net anchoring • Powdercoated green for ultimate harsh climate protection • For permanent installation, with optional ground sleeves available • Posts sold in pairs; nets sold separately.

GSTNPOST278: 2-7/8" EXTERNAL RATCHET TENNIS POSTS, GREEN

WEIGHT: 46 LBS/PR, GROUND COURIER SERVICE, 48 HOUR SHIP

PREMIUM TENNIS NETS provide long-lasting durability for optimal play • 42' length meets official specifications • Constructed of high-quality braided polyethylene with a heavy-duty vinyl-coated headband • Wooden dowels included • Sold in eases; posts sold separately.

GSTNETAUS: 42' PREMIUM TENNIS NET, 3.0 MM POLYETHYLENE

WEIGHT: 20 LBS/EA, GROUND COURIER SERVICE, 48 HOUR SHIP

GSTNET30LS: 42' PREMIUM TENNIS NET, 3.5 MM POLYETHYLENE

WEIGHT: 22 LBS/EA, GROUND COURIER SERVICE, 48 HOUR SHIP

GSTNET30LSDC: 42' PREMIUM TENNIS NET, 3.5 MM POLYETHYLENE, DOUBLE CENTER

WEIGHT: 23 LBS/EA, GROUND COURIER SERVICE, 48-HOUR SHIP

TENNIS ACCESSORIES

Heavy-duty **TENNIS GROUND SLEEVES** allow for secure, semi-permanent set-up when permanent installation is not an option • Available for round, square, and external ratchet posts • Fabricated from Schedule 40 steel, PVC coated • Sold in pairs; posts sold separately.

GSTNGSERD: HEAVY-DUTY GROUND SLEEVES FOR ROUND TENNIS POSTS

WEIGHT: 29 LBS/PR, GROUND COURIER SERVICE, 48 HOUR SHIP

GSTNGSEQ: HEAVY-DUTY GROUND SLEEVES FOR SQUARE TENNIS POSTS

WEIGHT: 29 LBS/PR, GROUND COURIER SERVICE, 48 HOUR SHIP

GSTNSLV278: HEAVY-DUTY GROUND SLEEVES FOR EXTERNAL RATCHET TENNIS POSTS

WEIGHT: 13 LBS/PR, GROUND COURIER SERVICE, 48 HOUR SHIP

Top-quality **TENNIS NET CENTER STRAP** prevents net from swaying when contact with ball occurs • Made of 100% synthetic nylon webbing for strength and longevity • Use GSTNANCH anchor (sold separately) to secure strap at ground level • Straps include necessary hardware.

GSTCSTRAP: TENNIS NET CENTER STRAP

WEIGHT: 4 LBS/EA, GROUND COURIER SERVICE, 48 HOUR SHIP

GSTNANCH: GROUND ANCHOR FOR TENNIS NET STRAP

WEIGHT: 10 LBS/EA, GROUND COURIER SERVICE, 48 HOUR SHIP

TETHERBALL

GARED® TETHERBALL SYSTEMS provide a fun and economical game that will keep kids busy for hours! • Post is constructed of 2-3/8" O.D. heavy-gauge galvanized steel that will stand up to any playground wear and tear • Post is 12' tall, with 2' in ground for maximum stability • For semi-permanent or permanent installation • Standard-size tetherball and heavy nylon rope for ball attachment are included • Sleeved tetherball system includes ground sleeve so post may be removed when not in use • Model 6827 locking covers can be purchased as an upgrade to further prevent theft or tampering with sleeve covers.

6809: INGROUND TETHERBALL SYSTEM

WEIGHT: 40 LBS/EA, GROUND COURIER SERVICE, 24 HOUR SHIP

6812: SLEEVED TETHERBALL SYSTEM, INCLUDES SLEEVES

WEIGHT: 45 LBS/EA, GROUND COURIER SERVICE, 24 HOUR SHIP

Play indoors in the gym or outside on the playground with the **GARED® PORTABLE TETHERBALL SYSTEM** • Portable design allows for easy transport and storage • Constructed of 2-3/8" O.D. heavy-gauge galvanized steel • Post is 10' tall with a 40" heavy chrome base for greater stability of unit • Standard-size tetherball and heavy nylon rope for ball attachment are included.

6811: PORTABLE TETHERBALL SYSTEM

WEIGHT: 96 LBS/EA, TRUCK, FREIGHT CLASS 70, 24 HOUR SHIP

TETHERBALL ACCESSORIES

6805: STANDARD TETHERBALL WITH NYLON ROPE

WEIGHT: 7 LBS, GROUND COURIER SERVICE, 24 HOUR SHIP

6824: TETHERBALL GROUND SLEEVE, 2-3/8"

WEIGHT: 3 LBS, GROUND COURIER SERVICE, 24 HOUR SHIP

6827: LOCKING COVER FOR 2-3/8" TETHERBALL GROUND SLEEVES

WEIGHT: 1 LB /EA, GROUND COURIER SERVICE, 24 HOUR SHIP



GSTNPOST278



GSTCSTRAP



6809





FIELD SPORT EQUIPMENT

You may already know about GARED's dominance in the sporting goods industry in the design and manufacture of premium basketball equipment. But you might not know that we've carried that same dedication to innovation and quality to our line of field sports equipment as well. Developed using the same experienced engineering team as our highly regarded basketball line, our field sports products were created with the basic needs of coaches and players in mind - safety, ease of assembly, and tons of standard features. And now with the fastest lead times in the industry and an even bigger selection of products and accessories than ever before, there's no reason why you should shop anywhere else for your facility's soccer, lacrosse, and football needs!





TOUCHLINE STRIKER SOCCER GOAL

STRIKER GOAL GROUND BAR NET CHANNEL

TOUCHLINE™ MATCH PLAY SOCCER GOALS

Score the golden goal with the **TOUCHLINE™ STRIKER™ ALUMINUM SOCCER GOALS!** • The ultimate match-play soccer goals have many features to take your game to the next level. • Extruded aluminum frame is lightweight for ease of assembly and transport • 8' x 24' size is approved for competition play and meets FIFA specifications • Welded one-piece goal frame corners provide strength and rigidity with no visible hardware • Crossbar, uprights, side bars, and ground bar all contain a channel for easy and secure net clip insertion as well as keeping the net securely fastened. • Crossbar, uprights, side bars, and ground bar are powdercoated white for durability and protection against weather elements.

TOUCHLINE™

S O C C E R G O A L S



GOAL SIZE	GOAL SHAPE	PORTABLE MODEL #	WEIGHT (LBS/PR)
8' x 24'	SQUARE	SGSQ824SPT	494
7' x 21'	SQUARE	SGSQ721SPT	439
6' x 12'	SQUARE	SGSQ612SPT	341
8' x 24'	ROUND	SGRD824TSPT	523
7' x 21'	ROUND	SGRD721SPT	494
6' x 12'	ROUND	SGRD612SPT	359

Permanent, Semi-Permanent and Custom Soccer Goals available, please email soccer@garedsports.com for information.

Score with GARED'S line of **TOUCHLINE™ ALL-STAR ALUMINUM SOCCER GOALS!** • Enhanced features and added goal styles and sizes make GARED your one-stop source for every level of soccer play • Extruded aluminum frame is lightweight for ease of assembly and transport • 8' x 24' size is approved for competition play and meets NCAA, NHSAA, and FIFA specifications • Welded one-piece goal frame corners provide strength and rigidity with no visible hardware • Crossbar and uprights contain a channel along the backside of the goal for easy and secure net clip insertion • Heavy-duty 1-5/8" galvanized steel backstays and adjustable one-piece ground bar adds counterweight and stability to goal • Crossbar and uprights are powdercoated white for protection against weather elements • Each goal includes one crossbar and two uprights, two backstays, one-piece ground bar, net attachment clips, four 14" steel ground stakes, and hardware • Semi-permanent goals have uprights extended 2' at bottom end for insertion into ground sleeves (included with goals) • Permanent goals have uprights extended 2' at bottom end for insertion into a permanent concrete footing • For portable goals, we recommend adding optional underground anchors (model SGUA) to decrease risk of goal tipping over • Optional wheel adapter kit (model SGWK) available to allow easy transport of portable goals • Goals sold in pairs; nets sold separately • Smaller goal sizes available upon request.



SGSQ SERIES: ALL-STAR I SOCCER GOALS, 4" SQUARE FRAME, 8 YEAR LIMITED WARRANTY

SEE CHART FOR WEIGHTS, TRUCK, FREIGHT CLASS 70, 48 HOUR SHIP

GOAL SIZE	GROUND BAR INCLUDED	PORTABLE MODEL #	WEIGHT (LBS/PR)
8' x 24'	YES	SGSQ824PT	407
7' x 21'	YES	SGSQ721PT	391
6 1/2' x 18'	YES	SGSQ618PT	368
6' x 12'	YES	SGSQ612PT	277

Permanent, Semi-Permanent and Custom Soccer Goals available, please email soccer@garedsports.com for information.



SGRD SERIES: ALL-STAR II SOCCER GOALS, 4" ROUND FRAME, 8 YEAR LIMITED WARRANTY

SEE CHART FOR WEIGHTS, TRUCK, FREIGHT CLASS 70, 48 HOUR SHIP

GOAL SIZE	GROUND BAR INCLUDED	PORTABLE MODEL #	WEIGHT (LBS/PR)
8' x 24'	YES	SGRD824PT	378
7' x 21'	YES	SGRD721PT	336
6 1/2' x 18'	YES	SGRD618PT	302
6' x 12'	YES	SGRD612PT	259

Permanent, Semi-Permanent and Custom Soccer Goals available, please email soccer@garedsports.com for information.

TOUCHLINE SOCCER STANDARD FEATURES



NET ATTACHMENT SYSTEM

Securely attach GARED's Touchline Net with our Easy-Twist™ attachment clips.



ADJUSTABLE GROUND BAR

GARED's adjustable ground bar provides extra stabilization for play and customization to fields.



DURABLE POST BRACKET SYSTEM

GARED's line of Touchline Goals are stabilized by our bracketing system which securely attaches the backstays to the goal face.



GARED NET CORNER MARKING SYSTEM

GARED's Net Corner Marking System makes attaching a net easy with a bright blue tag in each corner of the net.

TOUCHLINE™ CLUB & PRACTICE SOCCER GOALS

GARED'S line of **TOUCHLINE™ RECTANGULAR FRAME ALUMINUM SOCCER GOALS** are pitch perfect for soccer clubs and complexes • Extruded aluminum frame is lightweight for ease of assembly and transport • Welded one-piece goal frame corners provide strength and rigidity with no visible hardware • Crossbar and uprights contain a channel along the backside of the goal for easy and secure net clip insertion • Heavy-duty 1-5/8" galvanized steel backstays and adjustable one-piece ground bar adds counterweight and stability to goal • Crossbar and uprights are powdercoated white for protection against weather elements • Each goal includes one crossbar and two uprights, two backstays, one-piece ground bar if applicable (please see product chart), net attachment clips, four 14" steel ground stakes, and hardware • Semi-permanent goals have uprights extended 2' at bottom end for insertion into ground sleeves (included with goals) • Permanent goals have uprights extended 2' at bottom end for insertion into a permanent concrete footing • For portable goals, we recommend adding optional underground anchors (model SGUA) to decrease risk of goal tipping over • Optional wheel adapter kit (model SGWK) available to allow easy transport of portable goals • Goals sold in pairs; nets sold separately • Smaller goal sizes available upon request.



SG2 SERIES: ALL-STAR RECREATIONAL SOCCER GOALS

SGRT SERIES: ALL-STAR RECREATIONAL SOCCER GOALS - 4" X 2" RECTANGULAR FRAME

8 YEAR LIMITED WARRANTY

SEE CHART FOR WEIGHTS, TRUCK, FREIGHT CLASS 70, 48 HOUR SHIP

GOAL SIZE	GROUND BAR INCLUDED	PORTABLE MODEL #	WEIGHT (LBS/PR)
8' x 24'	YES	SGRT824PT	335
7' x 21'	YES	SGRT721PT	297
6 1/2' x 18'	YES	SGRT618PT	266
6' x 12'	NO	SGRT612PT	228

Permanent, Semi-Permanent and Custom Soccer Goals available, please email soccer@garedsports.com for information.



SMALL SIDED SOCCER GOALS

GARED is excited to introduce our brand new line of **TOUCHLINE™ SMALL SIDED SOCCER GOALS!** • These goals are popular for playing **5-A-SIDE, 7-A-SIDE, and 9-A-SIDE** soccer games in the U.S, as well as all over the world • Available in 4' x 8', 4' x 12', 4' x 16', 6' x 16', and 7' x 16' sizes • All goals have 3" (80 mm) round extruded aluminum uprights and crossbar, which are lightweight for ease of assembly and transport • Crossbar and uprights are powdercoated white for protection against weather elements • Welded one-piece goal frame corners provide strength and rigidity with no visible hardware • Goal frame contains a channel along the entire backside for simple and secure net clip insertion • Heavy-duty 1-5/8" galvanized steel backstays and adjustable one-piece ground bar adds counterweight and stability to goal • Each goal includes one crossbar and two uprights, two backstays, one-piece ground bar, net attachment clips, four 14" steel ground stakes, and assembly hardware • Semi-permanent (socketed) goals have uprights extended 2' at bottom end for insertion into ground sleeves (included with goals) • Permanent goals have uprights extended 2' at bottom end for insertion into a permanent concrete footing • For portable

goals, we recommend adding optional anchors (model SGUA or SGSA) to secure goals and decrease risk of tipping over • Optional wheel adapter kit (model SGWK) available to allow easy transport of portable goals • Goals sold in pairs; nets sold separately.

SGRD5, SGRD7, SGRD9 SERIES: TOUCHLINE™ SMALL SIDED SOCCER GOALS WITH 3" ROUND FRAME

4 YEAR LIMITED WARRANTY, SEE CHART FOR WEIGHTS, TRUCK, FREIGHT CLASS 70, 2 WEEK SHIP

GOAL SIZE	GAME	GOAL NET	PORTABLE MODEL #	WEIGHT (LBS/PR)
4' X 8'	5-A-SIDE	SN48-3W	SGRD548PT	194
4' X 12'	5-A-SIDE	SN412-3W	SGRD5412PT	223
4' X 16'	5-A-SIDE	SN416-3W	SGRD5416PT	252
6' X 16'	7-A-SIDE	SN616-3W	SGRD7616PT	301
7' X 16'	9-A-SIDE	SN716-3W	SGRD9716PT	323



ALL STAR II FIFA SOCCER GOAL

Kick it up on a global level! **GARED INTERNATIONAL FIFA SOCCER GOALS** have the popular design of soccer goals across the world • Extruded aluminum frame is lightweight for ease of assembly and transport • 8' x 24' size is approved for competition play and meets FIFA specifications • Welded one-piece goal frame corners provide strength and rigidity with no visible hardware • Crossbar and uprights contain a channel along the backside of the goal for easy and secure net clip insertion • Crossbar and uprights are powdercoated white for protection against weather elements • Net is stretched out to form a box-like shape by attaching to two steel back stanchions placed 32' apart and 8' behind each front goal upright • Each goal includes one crossbar and two uprights, upright ground sleeves, 2" O.D. • Back stanchions with ground sleeves, net attachment clips, and hardware • FIFA goal must be anchored into ground sleeves (included) or permanently into a concrete footing • Goals sold in pairs; nets sold separately • Must use SNFIFA net with this style goal.

SGRD824I: ALL STAR II FIFA SOCCER GOAL

8 LIMITED YEAR WARRANTY
WEIGHT: 260 LBS/PR, TRUCK, FREIGHT CLASS 70, 48 HOUR SHIP



COMBINATION SOCCER/FOOTBALL GOAL is the perfect alternative for facilities with budget constraints and/or limited field space • Allows both soccer and football to be played on a single versatile unit • Soccer goal is 8' x 24' in size and constructed of 4" square steel uprights • Soccer backstays are constructed of 1-5/8" heavy-gauge steel for added stability • Football uprights are made of 1-5/8" heavy-gauge steel and extend 10' above the football crossbar and span 23' 4" for high school specifications • Football crossbar and uprights are detachable for even greater versatility • Entire unit is powdercoated white to protect from weather elements • Each unit includes ground sleeves for maximum stability and semi-permanent installation • Use any style standard 8' x 24' soccer net with this unit • Goals sold in pairs; nets sold separately • PPSQF Series optional post padding is available and recommended for safety.

FGP200: COMBINATION SOCCER/FOOTBALL GOAL

5 YEAR LIMITED WARRANTY
WEIGHT: 1500 LBS/PR, TRUCK, FREIGHT CLASS 70, 1 WEEK SHIP

TOUCHLINE™ SOCCER NETS & EASY-TWIST™ NET CLIPS

PREMIUM SOCCER NETS are constructed of high-tenacity polypropylene to provide maximum strength during relentless play • Knotless netting ensures safety and ease of set up • All nets include net clip attachments for safely securing net to goal • Your choice of white or orange • All nets feature blue location tags to help with proper installation • Meets NCAA, NHSAA, and FIFA specifications.

SN SERIES - SOCCER NETS

SEE CHART FOR WEIGHTS, GROUND COURIER SERVICE, 24 HOUR SHIP

MODEL #	GOAL SIZE	NET STRENGTH	COLOR	WEIGHT (LBS/ PR)
SNFIFA	8' x 24'	4 MM	White	32
SN824-4HEX	8' x 24'	4 MM	White	26
SN824-4W	8' x 24'	4 MM	White	33
SN824-4O	8' x 24'	4 MM	Orange	33
SN824-3W	8' x 24'	3 MM	White	23
SN824-3O	8' x 24'	3 MM	Orange	23
SN721-3W	7' x 21'	3 MM	White	17
SN721-3O	7' x 21'	3 MM	Orange	17
SN618-3W	6 1/2' x 18'	3 MM	White	12
SN618-3O	6 1/2' x 18'	3 MM	Orange	12
SN612-3W	6' x 12'	3 MM	White	10
SN49-3W	4' x 9'	3 MM	White	10

* Small Sided Goal Nets listed in goal chart



SOCCER NET



SOCCER NETCLIPS



SOCCER NET TAG

SGNC: EASY-TWIST™ SOCCER NET CLIPS

1 LB WEIGHT, GROUND COURIER SERVICE, 24 HOUR SHIP

UNDERGROUND ANCHORS provide added stability to portable soccer goals and decrease the risk of goals tipping over • Anchors are made of 2-3/8" O.D. galvanized steel, and are 18" in length • Each anchor assembly includes the anchor pipe and strap clamp for bolting to the soccer backstays • Anchor pipe must be installed in a concrete footing before attaching to backstays • One set of four anchors is strongly recommended for a pair of goals for increased safety and goal securement.

SGSA: UNDERGROUND SOCCER GOAL SCREW ANCHORS, SET OF FOUR

WEIGHT: 8 LBS/SET, GROUND COURIER SERVICE, 24 HOUR SHIP

SGUA: UNDERGROUND SOCCER GOAL ANCHORS, SET OF FOUR

WEIGHT: 8 LBS/SET, GROUND COURIER SERVICE, 24 HOUR SHIP

Convert any standard **GARED TOUCHLINE™ SOCCER GOAL** into a folding goal with our **BACKSTAY CONVERSION BRACKET™** • The innovative backstay attachment easily fits onto the back of the face of the goal and allows the backstays to fold easily for easy goal storage • Additionally, it works with all round, square and rectangular goals with standard backstay and ground bar configuration.

SGBF: SOCCER GOAL BACKSTAY FOLDING BRACKET, SET OF FOUR

WEIGHT: 16 LBS/SET, GROUND COURIER SERVICE, 24 HOUR SHIP

WHEEL ADAPTER KIT allows for easy transport of portable soccer goals • Reduces wear and tear from dragging goals across field • 10" wheels fit snugly into bottom of upright for quick and easy portability • Fits any soccer goal with 1-5/8" to 2" backstays • Cannot be used for semi-permanent or permanent goals, or for combination soccer/football goal • Kit includes a set of four wheels to transport one pair of goals.

SGWK: SOCCER GOAL WHEEL ADAPTER KIT, SET OF FOUR

WEIGHT: 79 LBS/KIT, GROUND COURIER SERVICE, 48 HOUR SHIP

SOCCER GOAL CORNER FLAGS AND FLAG ANCHORS allows for easy field boundary marking.

SGCFA: SOCCER GOAL CORNER FLAG ANCHOR, SET OF FOUR

WEIGHT: 79 LBS/KIT, GROUND COURIER SERVICE, 48 HOUR SHIP

SGCF: SOCCER GOAL CORNER FLAG, SET OF FOUR

WEIGHT: 79 LBS/KIT, GROUND COURIER SERVICE, 48 HOUR SHIP

SOCCER POST PADS

WRAP-AROUND AND FITTED SOCCER POST PADS cover soccer goal uprights and protect players from injury • Made of 1" foam covered in UV-resistant vinyl for maximum protection and long life • Wraps around post with Velcro® strips in back for closure • For use on both square and round posts.

PP4WR: WRAP-AROUND SOCCER POST PAD

WEIGHT: 4 LBS, GROUND COURIER SERVICE, 24 HOUR SHIP

- For use with 4" round and square posts
- For recreational/practice use only
- Available in black only

PP4SQF: FITTED SOCCER POST PAD

WEIGHT: 4 LBS, GROUND COURIER SERVICE, 24 HOUR SHIP

- For use with 4" square posts only
- For recreational/practice use only
- Available in black only

SP4SQF: COMPETITION FITTED SOCCER POST PAD

WEIGHT: 4 LBS, GROUND COURIER SERVICE, 24 HOUR SHIP

- For use with 4" square posts only
- For competition play and recreational/practice use
- Meets National High School Federation soccer rules
- Available in white only



VELCRO® PAD ATTACHMENT

ALPHATEC™ SOCCER SCOREBOARDS

Our **GS-MS3 PORTABLE SOCCER SCOREBOARD** provides versatile and budget-friendly scoring for any organization! • This model is battery-powered and includes wheels, so just simply fold up compactly and roll away for easy transport and storage • Brilliant LED numbers are 9" and 6" tall in red • Scoreboard cabinet is constructed of 18-gauge durable galvanized steel with a premium powdercoat finish for lasting protection from weather elements • Standard powdercoat colors are royal blue, navy blue, green, purple, red, maroon, and black • Scoreboard display dimensions: 78" L x 52" W x 4" D • Storage dimensions: 38" L x 52" W x 4" D • Will score soccer, football, field hockey, and lacrosse.

GS-MS3: 78" X 52" PORTABLE SOCCER SCOREBOARD

2 YEAR WARRANTY, WEIGHT: 120 LBS, TRUCK, FREIGHT CLASS 85

Our **GS-SK2 PORTABLE SOCCER SCOREBOARD** provides convenient tabletop scoring for any size program or facility • This lightweight model includes a handle for transport, making it perfect for traveling teams • Brilliant LED numbers are 9" and 6" tall in red • 18-gauge durable galvanized steel scoreboard cabinet has a premium powdercoat finish for lasting protection against weather elements • Available in black only • Scoreboard dimensions: 52" L x 28" W x 8" D • Scoreboard package for cable models includes controller with operator's keyboard, loud buzzer horn, and control cable • Electrical requirements: Wall transformer input – 120 volts AC; Output – 10 volts AC • Will score soccer, basketball, volleyball, and wrestling.

GS-SK2: 52" X 28" PORTABLE SOCCER SCOREBOARD

2 YEAR WARRANTY, WEIGHT: 60 LBS, GROUND COURIER SERVICE



GS-MS3



GS-SK2



FIELD FORCE™ INDOOR & OUTDOOR NETTING

Are spectators getting a work out avoiding off the mark shots? • Are your facility HVAC and lighting maintenance costs mounting from ball abuse? • GARED's line of **FIELD FORCE INDOOR AND OUTDOOR NETTING** offers solutions to your problem • Our experienced team of engineers and draftsmen can assist you in deciding which equipment options best fit your facility, help you write product specifications, and decide how to configure your courts for multiple sports and activities.

FIELD FORCE™ OUTDOOR NETTING

Keep the ball in the field of play with **GARED'S FIELD FORCE™ OUTDOOR NETTING** • Each application is customized for your field's play requirements • Call for a customized quote • Please allow 6 to 8 weeks for delivery.



FIELD FORCE™ INDOOR NETTING

allows for maximizing of group activities in a shared space • Engineered for the highest performance athletes • GARED's indoor netting is individually designed to meet each facility needs • Please allow 6 - 8 weeks for delivery.

SOCCER TRAINING AIDS

Keep your players on their game with the **GARED TOUCHLINE™ SOCCER FIELD FORCE SPORT BLOCKER AND REBOUNDERS!** • Fun and useful training aids for school teams, coaching clinics, youth leagues, or backyard play • Made of durable steel tubing for years of use • Portable and easy to assemble for on-the-go practice and training sessions • Each training aid includes a net with bungee cords for attachment, four ground stakes, and hardware.



The **GARED FIELD FORCE™ MULTI-SPORT BLOCKER** is an ideal training tool for any level of soccer player • A valuable aid for goalkeeper exercises, finishing drills, and target training • Panels are utilitarian and can be shifted and rearranged across or inside goal, and placed horizontal or vertical depending on needs • The high density net provides sufficient support for those perfect hits • Constructed of 1 1/4" steel tubing, the **FIELD FORCE** is lightweight, yet durable • Panels and net can be set at different angles for even more versatility • Sets up in no time with easy connection panel point secured with bungee straps • The panels are stabilized with steel ground anchors to withstand the hardest shots on the team • The entire system breaks down for easy storage in a travel bag.

FSSB: FIELD FORCE™ MULTI-SPORT BLOCKER

1 YEAR LIMITED WARRANTY, WEIGHT: 25 LBS/EA, GROUND COURIER SERVICE, 24 HOUR SHIP



RB0406

RB0406: ADJUSTABLE SOCCER REBOUNDER, 4' X 6'

WEIGHT: 19 LBS, GROUND COURIER SERVICE, 24 HOUR SHIP

- 4' X 6' compact size
- Adjustable for infinite playback angles
- Galvanized steel tubing, powdercoated white
- Orange net features center target with smaller mesh squares to encourage accuracy during drills



RB0612

RB0612: SOCCER REBOUNDER, 6' X 12'

WEIGHT: 36 LBS, GROUND COURIER SERVICE, 24 HOUR SHIP

- 6' X 12' size
- Galvanized steel tubing
- Black net features orange center with smaller mesh squares to withstand increased play
- Includes stabilizer legs extending 3' on each side of frame



SGCG

Convert any soccer pitch into a competition ready camogie field with **GARED'S CAMOGIE POST ADAPTERS**. Camogie is an ancient Irish sport, similar to lacrosse and field hockey, which is also considered the National Sport of Ireland. The female sport is referred to as camogie and the male version is referred to as hurling. As the popularity of camogie surges in the US, GARED's adapter system makes hosting tournaments an ease on any soccer pitch. The light-weight, adapter posts measure 20' in height and securely attach to any soccer goal with bungee cords. Each post is composed of 2 piece PVC pipe. The posts can also be used for Gaelic football and hurling games.

SGCG: CAMOGIE POST ADAPTERS

1 YEAR LIMITED WARRANTY, WEIGHT: 42 LBS/PAIR, TRUCK, FREIGHT CLASS 70, 48 HOUR SHIP



FHOG

GARED is proud to add to our growing field sports family our **DEFENDER™ FIELD HOCKEY OFFICIAL SIZE GOAL**! Constructed with a 2" square heavy duty steel frame face and 1" square supporting structure that is finished in a durable white powdercoat finish, GARED's Field Hockey goal can hold up to the rigors of even the roughest play. Goal measures regulation size of 7' H x 12' W x 4' deep and comes standard with 18" high x 1/2" thick outdoor grade painted bottom wood boards. Goals are sold in pairs and include two weather treated 2.5 mm, 1 3/4" square, black nets. Optional accessories include wheel adapter kit for easy transport when goals are not in use and 1/2" high density polyethylene bottom boards for the more extreme environments.

FHOG: FIELD HOCKEY OFFICIAL SIZE GOAL

2 YEAR LIMITED WARRANTY, WEIGHT: 200 LBS/PAIR, TRUCK, FREIGHT CLASS 70, 48 HOUR SHIP



8300

The **8300 OFFICIAL FUTSAL GOAL** meets all FIFA and US Futsal specifications. Goal is made of a 3" (8 cm) square extruded aluminum frame with large safety radius on all corners. The 2 m x 3 m frame is supported by 1 m deep 1 5/8" (41.28 m) O.D. Galvanized steel backstays and rear stabilizing bar. It features our easy connect net attachment. Standard finish is white powdercoat. Used with the 8305 Official Futsal Goal braided white net. Nets are sold separately. Futsal goals are sold in pairs. GARED is an official partner of US Futsal.

8300: OFFICIAL FUTSAL GOAL

2 YEAR LIMITED WARRANTY, WEIGHT: 214 LBS/PAIR, TRUCK, FREIGHT CLASS 70, 48 HOUR SHIP

8305: OFFICIAL FUTSAL GOAL NET

WEIGHT: 18 LBS/PAIR, GROUND COURIER SERVICE, 24 HOUR SHIP

OPTIONAL EQUIPMENT

8340: INDOOR FLOOR ANCHOR



8200

The **8200 OFFICIAL TEAM HANDBALL GOAL** meets all IHF Official Team Handball specifications. It is constructed of 3" (8 cm) square extruded aluminum frame with large safety radius on all corners. The 2 m x 3 m frame is supported by 1 m deep 1 5/8" (41.28 m) O.D. Galvanized steel backstays with the lower horizontal section being rubber padded for floor protection. It features our easy connect net attachment and portable sand bags for ballast (sand is not included). Standard finish is black powdercoat with white stripes. Used with the 8305 Official Team Handball Goal braided white net. Nets are sold separately. Handball goals are sold in pairs.

8200: OFFICIAL TEAM HANDBALL GOAL

2 YEAR LIMITED WARRANTY, WEIGHT: 214 LBS/PAIR, TRUCK, FREIGHT CLASS 70, 48 HOUR SHIP

8305: OFFICIAL TEAM HANDBALL GOAL NET

WEIGHT: 18 LBS/PAIR, GROUND COURIER SERVICE, 24 HOUR SHIP

OPTIONAL EQUIPMENT

8340: INDOOR FLOOR ANCHOR

SLINGSHOT™ LACROSSE GOALS

GARED'S new line of **SLINGSHOT™ PORTABLE LACROSSE GOALS** will satisfy the needs of lacrosse programs across the country in this rapidly-growing sport • Ideal for competition play, leagues, tournaments, practice, and recreational use • Official goals meet all NCAA and high school specifications • Uprights and crossbar are constructed from heavy-gauge, galvanized steel for ultimate strength • Our premium goal features thick flat steel ground bar providing added stability and reducing chance of ball deflection • Orange powdercoated finish is baked on for maximum protection against weather elements • Six-piece goal construction allows for no-hassle assembly • One-piece welded face construction with mitered corners provides a clean look and appealing design • Lacing cord included for lacing net to goal • Each goal includes four ground stakes for additional goal securement • **SOLD IN PAIRS; NETS INCLUDED.**

LG200: PREMIUM LACROSSE GOAL WITH FLAT WIND RESISTANT GROUND BAR AND 5MM NET

2 YEAR LIMITED WARRANTY, WEIGHT: 267 LBS/PR, TRUCK, 24 HOUR SHIP

- 4" wide x 3/8" thick ground bar
- Net attaches by weaving the cord around welded loops on back of uprights and crossbar
- Includes 5mm official SlingShot Net

LG100: STANDARD PORTABLE LACROSSE GOAL WITH 3MM NET

1 YEAR LIMITED WARRANTY, WEIGHT: 217 LBS/PR, TRUCK, 24 HOUR SHIP

- 2-3/8" wide x 3/8" thick ground bar
- Net attaches by lacing the cord around uprights and crossbar
- Includes 3mm official SlingShot Net



LG200

LG200 CORNER & NET LACING



LG100 CORNER & NET LACING

LG100

SLING SHOT™ lacrosse goals



LG50

The **GARED RECREATIONAL LACROSSE GOAL** is an affordable option for practice, recreational use, and backyard play • Goal frame and ground bar are constructed from 1-1/2" galvanized steel for excellent durability • Goal measures 6' in height and 6' in width • Orange powdercoat finish is baked on for maximum protection against weather elements • Nine-piece goal construction allows for simple assembly and ease of transport • Net attaches to goal with Velcro® strips for quick and easy set up • Each goal includes four ground stakes for additional goal securement • Ready for retail packaging • Sold in eases; nets are included.

LG50: RECREATIONAL LACROSSE GOAL WITH 2 MM NET

1 YEAR LIMITED WARRANTY, WEIGHT: 39 LBS/EA, GROUND COURIER SERVICE, 24 HOUR SHIP

LACROSSE ACCESSORIES

The **GARED FIELD FORCE™ MULTI-SPORT BLOCKER** is an ideal shooting training tool for any level of play lacrosse player • The high density net prevents the lacrosse ball from passing through, which eliminates chasing after errant shots • Constructed of 1 1/4" steel tubing, the **FIELD FORCE SPORT BLOCKER** is lightweight, yet durable • It extends player's shot range by 6 feet across and 3 feet above the goal • It sets up in no time with easy connection panel point secured with bungee straps • Panels are stabilized with steel ground anchors to withstand the hardest shots • The entire system breaks down for easy storage in a travel bag.

FSSB: FIELD FORCE™ MULTI-SPORT BLOCKER

1 YEAR LIMITED WARRANTY, WEIGHT: 25 LBS/EA, GROUND COURIER SERVICE, 24 HOUR SHIP

Top-quality **LACROSSE NETS** are made of knotless nylon and braided for maximum strength and optimal play • For 6'H x 6'W lacrosse goals only • Your choice of 3 mm, 4 mm or 6 mm nylon strength • Includes nylon lacing cord to attach net to goal • Sold in pairs; goals sold separately.

LN-6W: LACROSSE NET, 6 MM

WEIGHT: 23 LBS/PR, GROUND COURIER SERVICE, 24 HOUR SHIP

LN-4W: LACROSSE NET, 4 MM

WEIGHT: 23 LBS/PR, GROUND COURIER SERVICE, 24 HOUR SHIP

LN-3W: LACROSSE NET, 3 MM

WEIGHT: 13 LBS/PR, GROUND COURIER SERVICE, 24 HOUR SHIP

CHECK WWW.GAREDSports.COM FOR INFORMATION ABOUT OUR NEW LACROSSE SHOT CLOCKS!



REDZONE™ FOOTBALL GOALPOSTS

GARED REDZONE™ FOOTBALL GOALPOSTS are unyielding for the toughest high school, college, or recreational play environments • Newly re-designed with enhanced features for easier assembly and installation (some drilling in the field is required) • Meets all NCAA and NFHS specifications • Your choice of our popular 4 1/2" O.D. gooseneck with 5' offset, or our ultra-duty 5-9/16" O.D. gooseneck with 6' offset • Crossbar is 3 1/2" O.D. and top uprights are 2 3/8" O.D. and 20' tall for all models • Entire unit is 30' tall • Crossbars are 23' 4" apart for high school specifications and 18' 6" apart for college specifications • All models available with your choice of galvanized, yellow powdercoat, or white powdercoat • All models available for permanent, sleeve-mounted, or plate-mounted installation • Goalposts sold in pairs • Optional ground sleeves available for sleeve-mount models only, to allow semi-permanent installation of goal • Optional protective post pads available and recommended for safety.

FGP SERIES: HIGH SCHOOL FOOTBALL GOALPOSTS

5 YEAR LIMITED WARRANTY, SEE CHART FOR WEIGHT, TRUCK, FREIGHT CLASS 50, 24 HOUR SHIP

4 1/2" O.D. MODEL #	WEIGHT (LBS/PR)	5 9/16" O.D. MODEL #	WEIGHT (LBS/PR)	FINISH	MOUNTING TYPE
FGP401S	1103	FGP601S	1417	Galvanized	Permanent/Sleeve Mount
FGP401SW	1103	FGP601SW	1417	White	Permanent/Sleeve Mount
FGP401SY	1103	FGP601SY	1417	Yellow	Permanent/Sleeve Mount
FGP401P	1135	FGP601P	1439	Galvanized	Plate Mount
FGP401PW	1135	FGP601PW	1439	White	Plate Mount
FGP401PY	1135	FGP601PY	1439	Yellow	Plate Mount

FGP SERIES: COLLEGE FOOTBALL GOALPOSTS

5 YEAR LIMITED WARRANTY, SEE CHART FOR WEIGHT, TRUCK, FREIGHT CLASS 50, 24 HOUR SHIP

4 1/2" O.D. MODEL #	WEIGHT (LBS/PR)	5 9/16" O.D. MODEL #	WEIGHT (LBS/PR)	FINISH	MOUNTING TYPE
FGP402S	1083	FGP602S	1397	Galvanized	Permanent/Sleeve Mount
FGP402SW	1083	FGP602SW	1397	White	Permanent/Sleeve Mount
FGP402SY	1083	FGP602SY	1397	Yellow	Permanent/Sleeve Mount
FGP402P	1105	FGP602P	1419	Galvanized	Plate Mount
FGP402PW	1105	FGP602PW	1419	White	Plate Mount
FGP402PY	1105	FGP602PY	1419	Yellow	Plate Mount

Heavy-duty **GROUND SLEEVES** allow football goalposts to be semi-permanent allowing removal when not in use • Choose from 4 1/2" or 5 9/16" size • Sleeves are inserted 4' into soil for maximum goalpost stability.

FGP400GS: 4 1/2" FOOTBALL GOALPOST GROUND SLEEVE

WEIGHT: 124 LBS/PR, TRUCK, FREIGHT CLASS 50, 24 HOUR SHIP

FGP600GS: 5 9/16" FOOTBALL GOALPOST GROUND SLEEVE

WEIGHT: 136 LBS/PR, TRUCK, FREIGHT CLASS 50, 24 HOUR SHIP

COMBINATION SOCCER/FOOTBALL GOAL is the perfect alternative for facilities with budget constraints and/or limited field space • Allows both soccer and football to be played on a single versatile unit • Soccer goal is 8' x 24' in size and constructed of 4" square steel uprights • Football uprights are made of 1-5/8" heavy-gauge steel and extend 10' above the football crossbar and span 23' 4" for high school specifications.

FGP200: COMBINATION SOCCER/FOOTBALL GOAL

5 YEAR LIMITED WARRANTY, WEIGHT: 1500 LBS/PR, TRUCK, FREIGHT CLASS 70, 1 WEEK SHIP

FOOTBALL GOALPOST PADDING protects players from main post where body contact may occur • 6' high pad is constructed of 4" thick high-density urethane foam covered with 18 oz. UV-resistant coated vinyl • Standard colors available: black, marine blue, royal blue, navy blue, beige, yellow, orange, red, white, grey, kelly green, forest green, burgundy, and purple • Custom colors and graphics available – please call for quotation.

GSPPAD3: FOOTBALL GOALPOST PAD, FOR POST UP TO 4 1/2" O.D.

WEIGHT: 25 LBS/EA, GROUND COURIER SERVICE, 48 HOUR SHIP

GSPPAD4: FOOTBALL GOALPOST PAD, FOR POST UP TO 6" O.D.

WEIGHT: 25 LBS/EA, GROUND COURIER SERVICE, 48 HOUR SHIP



FGP401SW



EASY CROSSBAR ADJUSTMENT



FGP200



GOALPOST PAD



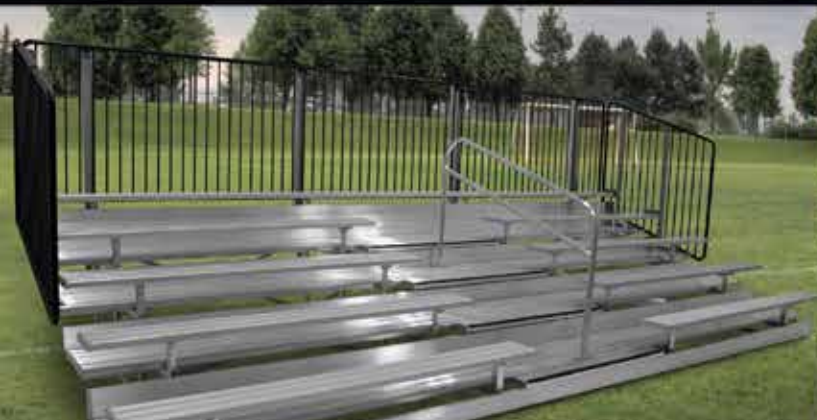

SPECTATOR™ SERIES BLEACHERS, BENCHES & SITE AMENITIES

Attract more visitors and spectators to your local park, playground, or outdoor sports venue. Start by providing plenty of durable, comfortable, and great-looking site and field amenities! GARED can help complete your indoor facilities and outdoor fields with our large selection of bleachers and player benches! Hit a homerun with softball and baseball field amenities completing any baseball diamond needs. Count on GARED's trusted reputation and years of manufacturing expertise, as our site and field amenities have been specifically designed and rigorously tested to stand up to demanding athletes, unpredictable weather conditions, and daily exposure to the general public. Contact GARED today to put the finishing touches on your park, outdoor venue, or sports field that will be sure to impress the crowd!



SPECTATOR™ SERIES TIP N' ROLL BLEACHERS

GARED TIP N' ROLL SERIES BLEACHERS are made to provide versatile indoor seating that can be easily tipped up and moved to other locations or for storage • These models are perfect for any location where space is limited but still offer seating for fans to view many different kinds of events at schools, gyms, athletic complexes, churches, YMCAs, boys & girls clubs, fairgrounds, and any other venue that need seats for spectators to cheer on their teams.



TRB0315

TRB SERIES: STANDARD TIP N' ROLL ALUMINUM BLEACHERS

SEE CHART FOR WEIGHTS, TRUCK, FREIGHT CLASS 85, 2-3 WEEK SHIP

- Aluminum frames
- Row 1 seat height 17", rise per row 6", row spacing 24"
- Anodized 10" aluminum seat plank
- Single (1) 10" foot plank on all rows
- Rubber foot pads protect units from marring floors
- Non-marring swivel casters
- **Up to 8 sets included in GARED's 48 Hour Quick Ship Program**

TRB DF SERIES: STANDARD TIP N' ROLL ALUMINUM BLEACHERS, DOUBLE FOOT PLANKS

- Features include all the same as above plus:
- Double (2) 10" foot planks on all rows
- **Up to 8 sets included in GARED's 48 Hour Quick Ship Program**

TIP N' ROLL BLEACHER MODEL #	ROWS	LENGTH	SEATING CAPACITY	ROW 1 SEAT HEIGHT	DOUBLE FOOT-PLANK	WEIGHT (LBS)
TRB0208	2	7' 6"	10	17"	NO	71
TRB0208DF	2	7' 6"	10	17"	YES	86
TR0215	2	15'	20	17"	NO	131
TRB0215DF	2	15'	20	17"	YES	160
TRB0221	2	21'	28	17"	NO	182
TRB0221DF	2	21'	28	17"	YES	223
TRB0227	2	27'	36	17"	NO	233
TRB0227DF	2	27'	36	17"	YES	285
TRB0308	3	7' 6"	15	17"	NO	114
TRB0308DF	3	7' 6"	15	17"	YES	143
TRB0315	3	15'	30	17"	NO	207
TRB0315DF	3	15'	30	17"	YES	265
TRB0321	3	21'	42	17"	NO	286
TRB0321DF	3	21'	42	17"	YES	367
TRB0327	3	27'	54	17"	NO	365
TR0327DF	3	27'	54	17"	YES	469

Custom lengths available, please call GARED at (800) 325-2682 for a quote and find your local dealer.

NOTE: BLEACHERS SHOULD NOT BE TIPPED UP OUTDOORS DUE TO POTENTIAL WIND SAFETY HAZARD

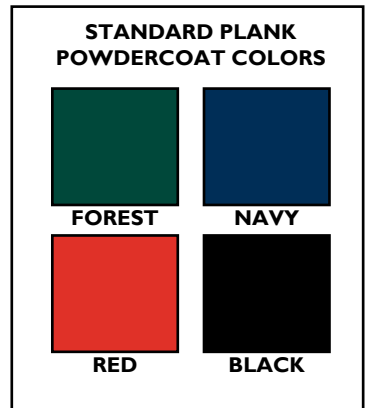

"DF" DOUBLE FOOT PLANK



TRB0315DF ROLLING



TRB0208DF



TRB0315DF STORED

SPECTATOR™ SERIES LOW RISE TIP N' ROLL BLEACHERS

GARED LOW RISE TIP N' ROLL SERIES BLEACHERS provide versatile seating for any indoor location that fans gather to view many different kinds of events • These low rise models do not require guardrail or aisles to meet building and safety codes • Great choice for schools, gyms, athletic complexes, YMCA, boys and girls clubs, churches, and many other places that need seats to view the action.



TRB0415LR ROLLING



TRB0415LR STORED

LOW RISE TIP N' ROLL BLEACHER MODEL #	ROWS	LENGTH	SEATING CAPACITY	ROW 1 SEAT HEIGHT	DOUBLE FOOT-PLANK	WEIGHT (LBS)
TRB0308LR	3	7' 6"	15	11"	NO	119
TRB0308DFLR	3	7' 6"	15	11"	YES	149
TRB0315LR	3	15'	30	11"	NO	220
TRB0315DFLR	3	15'	30	11"	YES	278
TRB0321LR	3	21'	42	11"	NO	305
TRB0321DFLR	3	21'	42	11"	YES	386
TRB0327LR	3	27'	54	11"	NO	390
TRB0327DFLR	3	27'	54	11"	YES	493
TRB0408LR	4	7' 6"	20	11"	NO	167
TRB0408DFLR	4	7' 6"	20	11"	YES	212
TRB0415LR	4	15'	40	11"	NO	308
TRB0415DFLR	4	15'	40	11"	YES	395
TRB0421LR	4	21'	56	11"	NO	426
TRB0421DFLR	4	21'	56	11"	YES	547

Custom lengths available, please call GARED at (800) 325-2682 for a quote and find your local dealer.

NOTE: BLEACHERS SHOULD NOT BE TIPPED UP OUTDOORS DUE TO POTENTIAL WIND SAFETY HAZARD

TRB LR SERIES: LOW RISE TIP N' ROLL ALUMINUM BLEACHERS

SEE CHART FOR WEIGHTS, TRUCK, FREIGHT CLASS 85, 2-3 WEEK SHIP

- Aluminum frames
- Row 1 seat height 11", rise per row 6", row spacing 24"
- Anodized 12" aluminum seat plank
- Single (1) 10" foot plank on all rows
- Rubber foot pads protect units from marring floors
- Non-marring swivel casters
- **Up to 8 sets included in GARED's 48 Hour Quick Ship Program**

TRB DFLR SERIES: LOW RISE TIP N' ROLL ALUMINUM BLEACHERS, DOUBLE FOOT PLANKS

- Features include all the same as above plus:
- Double (2) 10" foot planks on all rows
- **Up to 8 sets included in GARED's 48 Hour Quick Ship Program**

STANDARD PLANK POWDERCOAT COLORS

FOREST **NAVY**
RED **BLACK**



"DF" DOUBLE FOOT PLANK

SPECTATOR™ SERIES STATIONARY BLEACHERS

GARED SPECTATOR STATIONARY SERIES BLEACHERS provide high quality seating for any location that fans gather to view many different kinds of events including schools, athletic complexes, parks, amphitheaters, gyms, rodeo arenas, fairgrounds, and other places that needs seating to cheer on their team.



GSNB0315DF

GSNB SERIES: STATIONARY ALUMINUM BLEACHERS

SEE CHART FOR WEIGHTS, TRUCK, FREIGHT CLASS 85, 2-4 WEEK SHIP

- Aluminum frames
- 3 row 1 seat height 16", rise per row 6", row spacing 24"
- 5 row 1 seat height 17", rise per row 8", row spacing 24"
- Single (1) 10" foot plank on rows 2-4, double (2) 10" foot planks on rows 4 & above
- Anodized 10" aluminum seat plank
- Riser plank (6") under seat row 4 & above, (2) riser planks on top row only
- Chain link guardrail on 5,8 & 10 row units, including factory bias cut side panels

GSNB DF SERIES: STATIONARY ALUMINUM BLEACHERS, DOUBLE FOOT PLANKS

- Features include all the same as above plus:
- Double (2) 10" foot planks on all rows

STATIONARY BLEACHER MODEL #	ROWS	LENGTH	SEATING CAPACITY	ROW 1 SEAT HEIGHT	GUARD RAILING	DOUBLE FOOTPLANK	AISLE	WEIGHT (LBS)
GSNB0308	3	7' 6"	15	16"	NO	NO	NO	106
GSNB0308DF	3	7' 6"	15	16"	NO	YES	NO	136
GSNB0315	3	15'	30	16"	NO	NO	NO	198
GSNB0315DF	3	15'	30	16"	NO	YES	NO	256
GSNB0321	3	21'	42	16"	NO	NO	NO	272
GSNB0321DF	3	21'	42	16"	NO	YES	NO	352
GSNB0327	3	27'	48	16"	NO	NO	NO	348
GSNB0327DF	3	27'	48	16"	NO	YES	NO	452
GSNB0515	5	15'	50	17"	YES	NO	NO	815
GSNB0515DF	5	15'	50	17"	YES	YES	NO	872
GSNB0521	5	21'	70	17"	YES	NO	NO	1048
GSNB0521DF	5	21'	70	17"	YES	YES	NO	1129
GSNB0527	5	27'	90	17"	YES	NO	NO	1287
GSNB0527DF	5	27'	90	17"	YES	YES	NO	1390

Custom lengths available, please call GARED at (800) 325-2682 for a quote and find your local dealer.



GSNB0521



"DF" DOUBLE FOOT PLANK



GSNB0521DF



GSNB0521WAVP



GSNB0527WA

GSNB WA SERIES: STATIONARY ALUMINUM BLEACHERS

- Features include all the same as DF models plus:
- Available in 5, 8 & 10 rows high
- Aisles with handrails
- Riser planks on all rows
- Optional powdercoated vertical picket guardrail

STATIONARY BLEACHER WITH AISLE MODEL #	ROWS	LENGTH	SEATING CAPACITY	ROW 1 SEAT HEIGHT	GUARD RAILING	DOUBLE FOOTPLANK	AISLE	WEIGHT (LBS)
GSNB0515WA	5	15'	40	17"	YES	YES	YES	1060
GSNB0521WA	5	21'	58	17"	YES	YES	YES	1246
GSNB0527WA	5	27'	78	17"	YES	YES	YES	1529
GSNB0815WA	8	15'	62	17"	YES	YES	YES	1681
GSNB0821WA	8	21'	91	17"	YES	YES	YES	2021
GSNB0827WA	8	27'	123	17"	YES	YES	YES	2487
GSNB1015WA	10	15'	76	17"	YES	YES	YES	2134
GSNB1021WA	10	21'	113	17"	YES	YES	YES	2556
GSNB1027WA	10	27'	153	17"	YES	YES	YES	3144

Custom lengths available, please call GARED at (800) 325-2682 for a quote and find your local dealer.



GSNB1021WA

STANDARD PLANK POWDERCOAT COLORS

	
FOREST	NAVY
	
RED	BLACK

SPECTATOR™ SERIES LOW RISE STATIONARY BLEACHERS



“DF” DOUBLE FOOT PLANK

GARED LOW RISE BLEACHERS provide high quality seating for any location that fans gather to view many different kinds of events • These models do not require guardrail or aisles to meet building and safety codes • Low rise bleachers are designed to be an economical choice for schools, athletic complexes, parks, amphitheatres, rodeo arenas, fairgrounds, and venues that need seats to cheer on their team and still consider their budgets.

GSNB LR SERIES: LOW RISE STATIONARY ALUMINUM BLEACHERS



SEE CHART FOR WEIGHTS, TRUCK, FREIGHT CLASS 85, 2-3 WEEK SHIP

- Available in 3 & 4 rows high
- Aluminum frames
- Row 1 seat height 10”, rise per row 6” / row spacing 24”
- Anodized 12” aluminum seat plank
- Single (1) 10” foot plank
- **Up to 8 sets included in GARED’s 48 Hour Quick Ship Program**

GSNB DFLR SERIES: LOW RISE STATIONARY ALUMINUM BLEACHERS, DOUBLE FOOT PLANKS

- Features include all the same as above plus:
- Double (2) 10” foot planks on all rows
- **Up to 8 sets included in GARED’s 48 Hour Quick Ship Program**

STANDARD PLANK POWDERCOAT COLORS

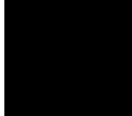
	
FOREST	NAVY
	
RED	BLACK

STATIONARY BLEACHER MODEL #	ROWS	LENGTH	SEATING CAPACITY	ROW 1 SEAT HEIGHT	GUARD RAILING	DOUBLE FOOTPLANK	AISLE	WEIGHT (LBS)
GSNB0308LR	3	7' 6"	15	10"	NO	NO	NO	112
GSNB0308DFLR	3	7' 6"	15	10"	NO	YES	NO	141
GSNB0315LR	3	15'	30	10"	NO	NO	NO	209
GSNB0315DFLR	3	15'	30	10"	NO	YES	NO	267
GSNB0321LR	3	21'	42	10"	NO	NO	NO	290
GSNB0321DFLR	3	21'	42	10"	NO	YES	NO	371
GSNB0408LR	4	7' 6"	20	10"	NO	NO	NO	158
GSNB0408DFLR	4	7' 6"	20	10"	NO	YES	NO	203
GSNB0415LR	4	15'	40	10"	NO	NO	NO	296
GSNB0415DFLR	4	15'	40	10"	NO	YES	NO	383
GSNB0421LR	4	21'	56	10"	NO	NO	NO	408
GSNB0421DFLR	4	21'	56	10"	NO	YES	NO	529

Custom lengths available, please call GARED at (800) 325-2682 for a quote and find your local dealer.

SPECTATOR™ TRANSPORTABLE SERIES BLEACHERS

GARED SPECTATOR TRANSPORTABLE SERIES BLEACHERS provide versatile mobile seating for any location that wants to have the ability to move seating from one field to another for fans gather to view different kinds of events • These bleachers are the perfect solution for schools, athletic complexes, parks, rodeo arenas, fairgrounds, and any other places that need seating in different locations on the ground. **NOTE: THESE BLEACHERS ARE NOT INTENDED FOR OVER THE ROAD USE, MAX 5 MPH TOWING SPEED**

GSNBTP SERIES: TRANSPORTABLE ALUMINUM BLEACHERS WITHOUT AISLES

- SEE CHART FOR WEIGHTS, TRUCK, FREIGHT CLASS 85, 2-4 WEEK SHIP
- Aluminum frames with galvanized steel lift angle for added strength while moving
 - Wheel attachment and drawbar attachment brackets included in each bleacher eliminating the need to share wheel attachments when moving multiple bleachers
 - Row 1 seat height 17", rise per row 8", row spacing 24"
 - Anodized 10" aluminum seat plank
 - Single (1) 10" foot plank on rows 2-3, double (2) 10" foot planks on rows 4 & above
 - Riser plank (6") under seat row 4 & above, (2) riser planks on top row
 - Chain link guardrail (factory bias cut side panels)

GSNBDFTP SERIES: TRANSPORTABLE ALUMINUM BLEACHERS WITHOUT AISLES, DOUBLE FOOT PLANKS

- SEE CHART FOR WEIGHTS, TRUCK, FREIGHT CLASS 85, 2-4 WEEK SHIP
- Features include all the same features above plus:
- Double (2) 10" foot planks on all rows



GSNB0527DFTP

TRANSPORTABLE BLEACHER WITHOUT AISLES MODEL #	ROWS	LENGTH	QTY SEATS	GUARD RAILING	DOUBLE FOOTPLANK	AISLE	WEIGHT (LBS)
GSNB0515TP	5	15'	50	YES	NO	NO	868
GSNB0515DFTP	5	15'	50	YES	YES	NO	926
GSNB0521TP	5	21'	70	YES	NO	NO	1086
GSNB0521DFTP	5	21'	70	YES	YES	NO	1167
GSNB0527TP	5	27'	90	YES	NO	NO	1310
GSNB0527DFTP	5	27'	90	YES	YES	NO	1413

Custom lengths available, please call GARED at (800) 325-2682 for a quote and find your local dealer.



GSNB0521WATP

SPECTATOR™ TRANSPORTABLE SERIES BLEACHERS

GSNBWATP SERIES: TRANSPORTABLE ALUMINUM BLEACHERS WITH AISLES

- SEE CHART FOR WEIGHTS, TRUCK, FREIGHT CLASS 85, 2-4 WEEK SHIP
- Features include all the same as DFTP Models plus:
- Aisles with handrails
 - Riser planks on all rows

TRANSPORTABLE BLEACHER WITH AISLES MODEL #	ROWS	LENGTH	QTY SEATS	GUARD RAILING	DOUBLE FOOTPLANK	AISLE	WEIGHT (LBS)
GSNB0515WATP	5	15'	42	YES	YES	YES	1082
GSNB0521WATP	5	21'	58	YES	YES	YES	1259
GSNB0527WATP	5	27'	78	YES	YES	YES	1525

Custom lengths available, please call GARED at (800) 325-2682 for a quote and find your local dealer.



GSNBTK

GSNBTK: TRANSPORT WHEEL KIT
WEIGHT 155 LBS, TRUCK, FREIGHT CLASS 85, 2-4 WEEK SHIP

- INCLUDES:**
- (2) Wheel and axle assemblies
 - (1) Drawbar pull tube assembly
 - (1) Jack assembly

SPECTATOR™ SERIES CUSTOM BLEACHERS

GARED can design and CUSTOM BUILD BLEACHERS to meet your seating needs, let us help you make the most of your space and budget.

NON-ELEVATED MODELS



ELEVATED MODELS

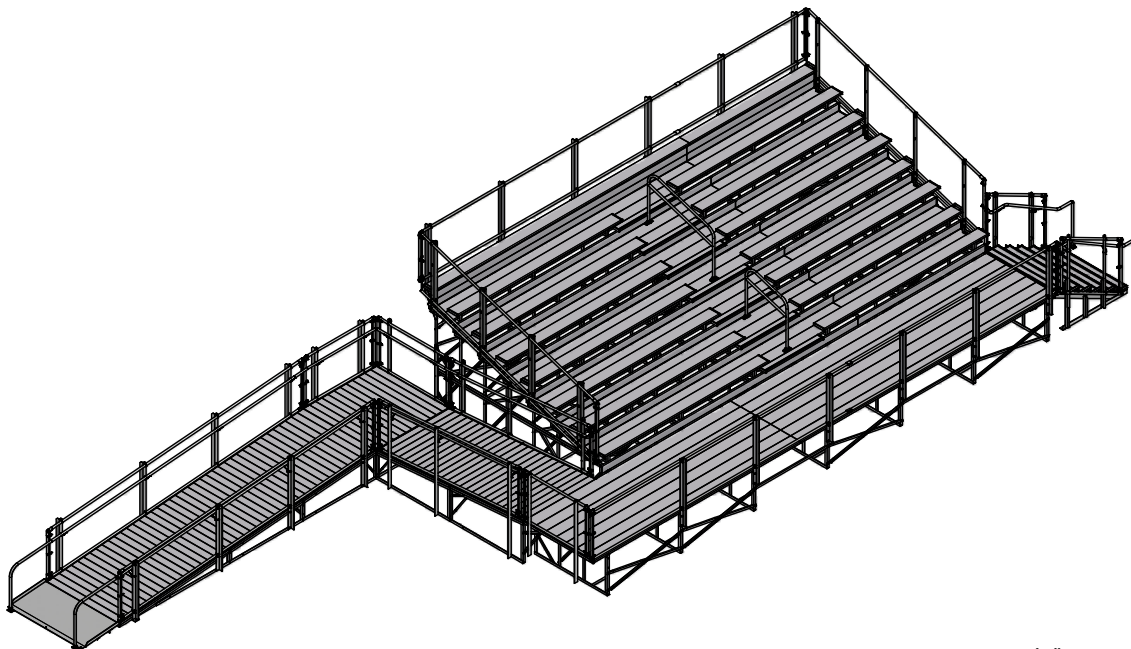

8 ROW X 31' 6" WITH RAMP AND STAIRS

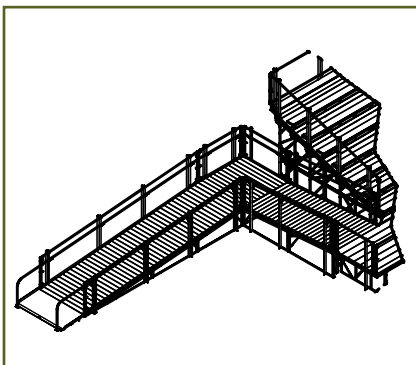

RAMPS

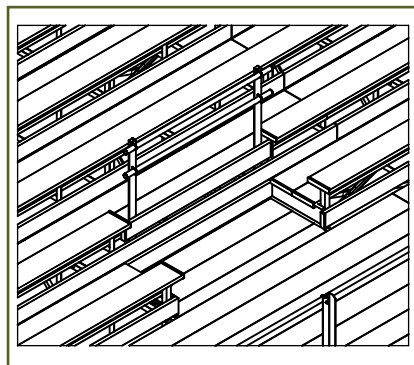

ADA SEATING

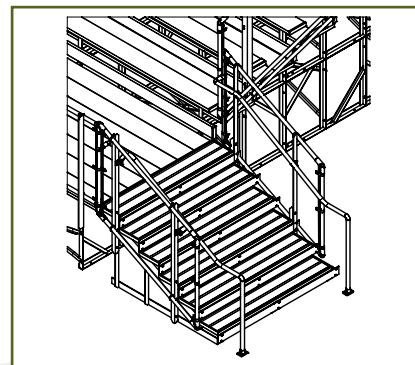

STAIRS

SPECTATOR™ SERIES BLEACHER COMPONENTS

Upgrade your facility & replace old unsafe wood bleacher boards. We can retrofit most existing structures with maintenance free **ALUMINUM PLANKS, COMPONENTS & BRACKETS** for a fraction of the cost of a new seating system.

SPECTATOR SERIES BLEACHERS, BENCHES & SITE AMENITIES

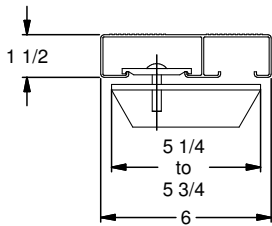
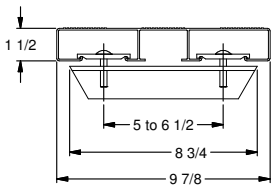
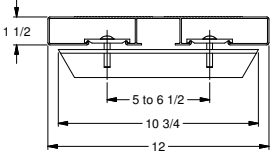
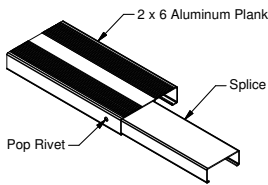
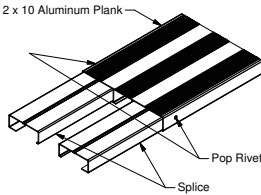
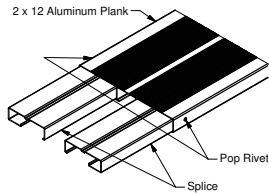
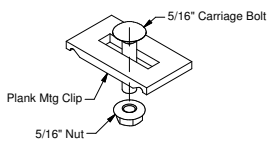
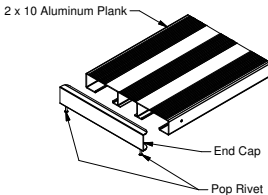
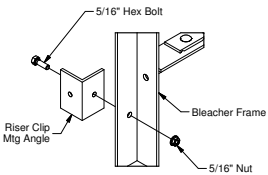
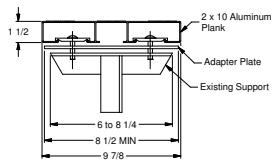
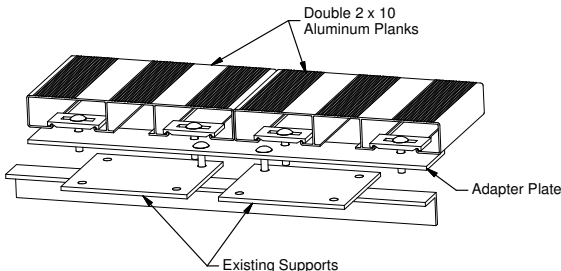
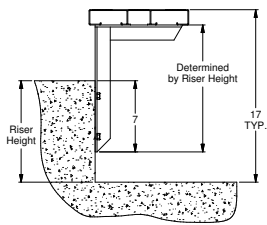
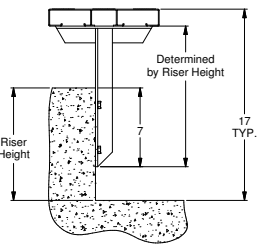
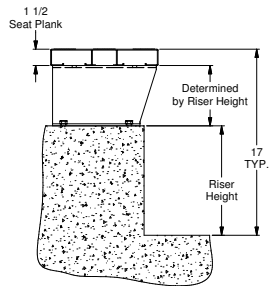
<p>PLANKS</p>			
	<p>6" Plank</p>	<p>10" Plank</p>	<p>12" Plank</p>
<p>SPLICE</p>			
	<p>6" Splice</p>	<p>10" Splice</p>	<p>12" Splice</p>
<p>PLANK ACCESSORY</p>			
	<p>Clip Assembly</p>	<p>End Cap</p>	<p>Riser Bracket</p>
<p>SEAT ADAPTER PLATE</p>			
	<p>Seat Adapter Plate</p>	<p>Double Foot Adapter Plate</p>	
<p>BRACKETS</p>			
	<p>"L" Bracket</p>	<p>"T" Bracket</p>	<p>"Z" Bracket</p>

SPECTATOR™ SERIES BENCHES

HEAVY-DUTY ALUMINUM BENCHES provide affordable, low-maintenance seating for players and fans • Seats and backs are comprised of 10" wide anodized aluminum planks • Frames are constructed of heavy-gauge galvanized steel for maximum support and years of use • Available in 7' 6", 15', 21' and 27' lengths • All sizes and styles available in portable, inground or surface mount installation methods.



BE15IGWB



BE15PTWB

BENCHES WITH BACKS SERIES

SEE CHART FOR WEIGHTS, TRUCK, FREIGHT CLASS 85, 1-2 WEEK SHIP

MODEL #	LENGTH	INSTALL TYPE	WEIGHT (LBS)
BE08IGWB	7' 6"	INGROUND	66
BE08SMWB	7' 6"	SURFACE MOUNT	66
BE08PTWB	7' 6"	PORTABLE	66
BE15IGWB	15'	INGROUND	112
BE15SMWB	15'	SURFACE MOUNT	112
BE15PTWB	15'	PORTABLE	113
BE21IGWB	21'	INGROUND	153
BE21SMWB	21'	SURFACE MOUNT	153
BE21PTWB	21'	PORTABLE	154
BE27IGWB	27'	INGROUND	194
BE27SMWB	27'	SURFACE MOUNT	194
BE27PTWB	27'	PORTABLE	195

BENCHES WITHOUT BACKS SERIES

SEE CHART FOR WEIGHTS, TRUCK, FREIGHT CLASS 85, 1-2 WEEK SHIP

MODEL #	LENGTH	INSTALL TYPE	WEIGHT (LBS)
BE08IG	7' 6"	INGROUND	36
BE08SM	7' 6"	SURFACE MOUNT	36
BE08PT	7' 6"	PORTABLE	35
BE15IG	15'	INGROUND	61
BE15SM	15'	SURFACE MOUNT	61
BE15PT	15'	PORTABLE	59
BE21IG	21'	INGROUND	83
BE21SM	21'	SURFACE MOUNT	83
BE21PT	21'	PORTABLE	80
BE27IG	27'	INGROUND	105
BE27SM	27'	SURFACE MOUNT	105
BE27PT	27'	PORTABLE	102



BE08SM



BE15PT

BENCHES WITH BACK SHELF SERIES

SEE CHART FOR WEIGHTS, TRUCK, FREIGHT CLASS 85, 1-2 WEEK SHIP

MODEL #	LENGTH	INSTALL TYPE	WEIGHT (LBS)
BE08PTWS	8'	PORTABLE	80
BE15PTWS	15'	PORTABLE	147
BE21PTWS	21'	PORTABLE	203
BE27PTWS	27'	PORTABLE	259

Our **INDOOR BENCH CONVERSION KIT** allows portable benches to be used indoors without damaging gym flooring • Rubber foot pads easily bolt onto bottom of bench legs • Kit includes two pads and necessary hardware • One kit needed per bench leg • Compatible with portable benches only.

GSBEKIT: INDOOR BENCH CONVERSION KIT
WEIGHT: 1 LB/KIT, GROUND COURIER SERVICE, 24 HOUR SHIP



BE08PTWS

SPECTATOR™ SERIES BIKE RACKS

TRADITIONAL BIKE RACKS are a great value while keeping the classic design that many parks prefer • Popular bike storage option for schools, playgrounds, parks, camps, and retail centers • Main framework and horizontal rack rails are manufactured with 1-5/8" high-tensile galvanized steel pipe with end caps • Vertical rack rails are made of 1/2" diameter hot-dipped galvanized solid steel electrically welded to the horizontal rails • Finish is painted with a durable outdoor aluminum enamel for protection against weather elements • Bright zinc-plated fasteners included • Optional baked-on polyester powdercoat finish is available • **ALL BIKE RACKS ARE COVERED BY 1 YEAR LIMITED WARRANTY.**

BRT SERIES: TRADITIONAL BIKE RACKS

SEE CHART FOR WEIGHTS, TRUCK, FREIGHT CLASS 70, 1-2 WEEK SHIP

MODEL #	LENGTH	SINGLE OR DOUBLE-SIDED	CAPACITY	WEIGHT (LBS)
BRT-5S	5'	Single-Sided	4 Bikes	70
BRT-5D	5'	Double-Sided	8 Bikes	80
BRT-10S	10'	Single-Sided	9 Bikes	125
BRT-10D	10'	Double-Sided	18 Bikes	144



BRT-10D



BRT-5D



BRM-5D



BRM-5S

MODERN BIKE RACKS are a budget-friendly storage choice with a contemporary design • Ideal for schools, playgrounds, parks, camps, and retail centers • Main framework and horizontal rack rails are manufactured with 1-5/8" high-tensile galvanized steel pipe with end caps • Vertical rack rails are made of 1/2" diameter hot-dipped galvanized solid steel electrically welded to the horizontal rails • Finish is painted with a durable outdoor aluminum enamel to withstand weather conditions • Bright zinc-plated fasteners included • Optional baked-on polyester powdercoat finish is available.

BRM SERIES: MODERN BIKE RACKS

SEE CHART FOR WEIGHTS, TRUCK, FREIGHT CLASS 70, 1-2 WEEK SHIP

MODEL #	LENGTH	SINGLE OR DOUBLE-SIDED	CAPACITY	WEIGHT (LBS)
BRM-5S	5'	Single-Sided	4 Bikes	65
BRM-5D	5'	Double-Sided	8 Bikes	75
BRM-10S	10'	Single-Sided	9 Bikes	115
BRM-10D	10'	Double-Sided	18 Bikes	134

LOOP-STYLE BIKE RACKS are popular for their long-lasting durability and sleek design • Great for schools, playgrounds, parks, camps, and retail centers • Constructed of 2 3/8" high-tensile galvanized steel pipe with cold-galvanized welds • Finish is painted with a durable outdoor aluminum enamel for protection in harsh outdoor climates • Optional baked-on polyester powdercoat finish available in your choice of black, bronze, blue, red, or green • Permanent/inground installation is standard for all loop bike racks • Optional surface-mount installation is available; please call for quotation.

BRL SERIES: LOOP-STYLE BIKE RACKS

SEE CHART FOR WEIGHTS, TRUCK, FREIGHT CLASS 70, 1-2 WEEK SHIP

MODEL #	LENGTH	CAPACITY	WEIGHT (LBS)
BRL2	3' 3"	5 Bikes	50
BRL3	5' 3"	7 Bikes	70
BRL4	7' 3"	9 Bikes	90
BRL5	9' 3"	11 Bikes	110



BRL3



BRL3-PC



BRL2-PC

BASEBALL & SOFTBALL FIELD AMENITIES



GARED's new line of **OUTDOOR BATTING AND MULTI-SPORT CAGES** are a great addition to any baseball field, practice facility, training camp, or driving range! • Available in 55' and 70' lengths to fit your space requirements • All cages include 3 1/2" O.D. posts in your choice of aluminum or galvanized steel for superior strength in outdoor play environments • Posts measure 12' from ground to top of post and are designed to be mounted into a permanent concrete footing • Nets measure 10' in height when assembled, with 2' draped on the ground • Nets attach with rope and pulleys to pull into desired position • NETS SOLD SEPARATELY - choose net model number and style from chart below.

OUTDOOR BATTING / MULTI-SPORT CAGES, 5 YEAR WARRANTY

SEE CHART FOR WEIGHTS, TRUCK, FREIGHT CLASS 70, 2 - 3 WEEK SHIP

STRUCTURE MODEL #	CAGE SIZE	POST O.D.	POST MATERIAL	# OF POSTS INCLUDED	MOUNTING	USES NET	WEIGHT (LBS)
4085-55	12' W x 10' H x 55' L	3 1/2"	Aluminum	8	Inground	4086 or 4088	570
4086-55	12' W x 10' H x 55' L	3 1/2"	Steel	8	Inground	4086 or 4088	456
4085-70	12' W x 10' H x 70' L	3 1/2"	Aluminum	10	Inground	4087 or 4089	784
4086-70	12' W x 10' H x 70' L	3 1/2"	Steel	10	Inground	4087 or 4089	640

OUTDOOR BATTING / MULTI-SPORT NETS

SEE CHART FOR WEIGHTS, TRUCK, FREIGHT CLASS 70, 24 HOUR SHIP

NET MODEL #	NET SIZE	COLOR	MESH SIZE	APPLICATION	WEIGHT (LBS)
4086	12' W x 12' H x 55' L	Black	3/4"	Multi-Sport	80
4088	12' W x 12' H x 55' L	Black	1-3/4"	Baseball / Softball	38
4087	12' W x 12' H x 70' L	Black	3/4"	Multi-Sport	100
4089	12' W x 12' H x 70' L	Black	1-3/4"	Baseball / Softball	49

Complete your baseball field with our premium line of **BASEBALL FOUL POLES!** • Poles are constructed of heavy-duty galvanized steel and include an 18" wide steel mesh wing panel • Entire unit is galvanized and powdercoated in optic yellow for maximum durability and protection in outdoor settings • Poles are available in 3 1/2" and 5 9/16" O.D. and 12', 15', 20', and 30' heights to meet the needs and budget requirements of your organization • Pole heights shown below are measured from ground level to top of pole; inground poles will be longer for mounting in concrete footing • Ground sleeves are available at an additional cost for inground (P) models; ground sleeves must be ordered with poles to ensure correct factory modification • Sold in pairs.

BSPOLE SERIES: BASEBALL FOUL POLES, 10 YEAR LIMITED WARRANTY

SEE CHART FOR WEIGHTS, TRUCK, FREIGHT CLASS 70, 2 - 3 WEEK SHIP

MODEL #	POLE O.D.	POLE HEIGHT	WING PANEL SIZE	MOUNTING	WEIGHT (LBS/PR)
BSPOLE-12P	3 1/2"	12'	4' L x 18" W	Inground	220
BSPOLE-15P	3 1/2"	15'	8' L x 18" W	Inground	272
BSPOLE-20P	3 1/2"	20'	12' L x 18" W	Inground	362
BSPOLE-30P	5 9/16"	30'	18' L x 18" W	Inground	1282
BSPOLE-12SM	3 1/2"	12'	4' L x 18" W	Surface Mount	190
BSPOLE-15SM	3 1/2"	15'	8' L x 18" W	Surface Mount	242
BSPOLE-20SM	3 1/2"	20'	12' L x 18" W	Surface Mount	332
BSPOLE-30SM	5 9/16"	30'	18' L x 18" W	Surface Mount	1078



BASEBALL FIELD ACCESSORIES

DRY LINE MARKERS are constructed with steel frames and galvanized steel buckets to combat rust and withstand weather elements • Hard rubber wheels provide extra durability on the field • Guide strip on lid allows quick and easy application • Hinged cover on bucket keeps marking compound dry • Handle lever adjusts easily to both 2" and 4" lines.

DRYLINE-25: 25-LB CAPACITY DRY LINE MARKER, 2-WHEEL
WEIGHT: 25 LBS, GROUND COURIER SERVICE, 48 HOUR SHIP

DRYLINE-50: 50-LB CAPACITY DRY LINE MARKER, 4-WHEEL
WEIGHT: 40 LBS, GROUND COURIER SERVICE, 48 HOUR SHIP



PETERSON BASEBALL SCOREMASTER SCOREBOOK simplifies scoring instructions for baseball or softball • 8 1/2" x 12" spiral-bound hard back with horizontal layout • Contains 25 games, team lineup and schedule cards • Order by the dozen.

SBS: PETERSON'S BASEBALL SCOREMASTER SCOREBOOK
WEIGHT: 6 LBS/DOZEN, GROUND COURIER SERVICE, 24 HOUR SHIP

PART NUMBER	PAGE	PART NUMBER	PAGE	PART NUMBER	PAGE	PART NUMBER	PAGE	PART NUMBER	PAGE	PART NUMBER	PAGE	PART NUMBER	PAGE
104	21	3105	7	6100	70	6824	83	8500	66	13P	59	2500-9124A	9
105	21	3107	7	6102	70	6825	74	8501	66	1442B	53	2500I	57
106	21	3109	7	6103	70	6825	83	8502	66	15CN	81	26WO	59
108	21	3111	7	6104	70	6827	74	8535	67	15N	81	3011RG	33
109	21	3115	7	6105	70	6827	83	8535PKG-SIT	67	15P	59	3011RG	33
140	58	3205	7	6106	70	6828	75	8536	66	1750B	53	3050RG	50
240	58	3207	7	6107	70	6829	75	8536PKG-SIT	67	2000+	57	3500I	56
266	59	3209	7	6108	70	6830	83	8537	66	2300-2030	9	39WO	59
724	58	3305	7	6183	70	6835	83	8550	58	2300-2030A	9	4000+	33
726	58	3500	56	6185	70	6840	83	8566	59	2300-2034	9	4000+	56
1000	57	3510	10	6251	78	7200	69	8800	57	2300-2034A	9	4000I	56
1100	11	3511	10	6283	77	7202	69	9054	30	2300-3040	9	4002-220V	13
1108	13	3512	10	6284	77	7203	69	9060	30	2300-3040A	9	4020R	13
1119	11	3513	10	6289	77	7205	69	9112	77	2300-3044	9	4040XL	13
1123	11	4002	13	6290	79	7207	69	9154	30	2300-3044A	9	4080-55	16
1131	10	4013	14	6291	79	7208	69	9172	30	2300-4060	9	4080-55LN	16
1132	10	4020	13	6292	79	7210	69	9249	31	2300-4060A	9	4080-70	16
1133	10	4025	14	6293	79	7216	69	9249	36	2300-4064	9	4080-70LN	16
1134	10	4030	14	6294	79	7220	69	9250	31	2300-4064A	9	4080BL-55	17
1135	10	4039	59	6295	79	7226	69	9251	32	2300-6090	9	4080BL-70	17
1141	10	4050	12	6400	76	7300	68	9252	32	2300-6090A	9	4081-55	16
1142	10	4066	59	6401	77	7302	68	9254	32	2300-6094	9	4081-70	16
1143	10	4075	17	6404	76	7305	68	9256	32	2300-6094A	9	4081BL-55	17
1144	10	4080	16	6405	76	7307	68	9257	32	2300-9120	9	4081BL-70	17
1145	10	4086	16	6406	77	7310	68	9305	29	2300-9120A	9	4085-55	108
1146	10	4086	108	6407	77	7315	68	9305	36	2300-9124	9	4085-70	108
1147	10	4087	16	6408	77	7320	68	9405	28	2300-9124A	9	4086-55	108
1148	10	4087	108	6410	78	7500	78	9408	28	2350-2030	9	4086-70	108
1149	10	4088	16	6411	77	7550	58	9616	24	2350-2030A	9	4110-STD	19
1156	11	4088	108	6412	78	7600	78	9618	24	2350-2034	9	4115-STD	19
1157	11	4089	16	6413	78	7610	78	9621	25	2350-2034A	9	4120-STD	19
1158	11	4089	108	6414	77	7700	75	9800	33	2350-3040	9	4125-STD	19
1159	11	4090	16	6415	77	7710	75	9803	33	2350-3040A	9	4130-STD	19
1171	10	4091	16	6422	77	7730	75	9804	33	2350-3044	9	4206-STD	19
1172	10	4095	16	6423	77	7740	75	9805	33	2350-3044A	9	4208-STD	19
1173	10	4195	19	6424	77	7750	75	9806	33	2350-4060	9	4210-STD	19
1174	10	4196	19	6425	77	7810	75	9930	79	2350-4060A	9	4212-STD	19
1175	10	4199	19	6426	77	7823	75	9933	79	2350-4064	9	4310-STD	19
1179	10	4404	10	6427	77	7824	75	9940	79	2350-4064A	9	4315-STD	19
1181	10	4405	10	6428	77	7825	75	11/8/9120	10	2350-6090	9	4320-STD	19
1182	10	4700	19	6429	77	7826	75	1015-12-00	77	2350-6090A	9	4325-STD	19
1183	10	4701	19	6430	77	7900	75	1020-12-00	77	2350-6094	9	4330-STD	19
1184	10	4702	19	6431	77	7910	75	1026-12-00	77	2350-6094A	9	4510-NSD	19
1185	10	5016	26	6432	77	7930	75	103MB	21	2350-9120	9	4515-NSD	19
1186	10	5018	26	6433	77	7940	75	103MPB	21	2350-9120A	9	4520-NSD	19
1187	10	5100	72	6440	66	7945	75	103MTK	21	2350-9124	9	4525-NSD	19
1188	10	5102	72	6446	76	7950	75	103MW	21	2350-9124A	9	4530-NSD	19
1189	10	5103	72	6448	66	8001	65	104PB	21	2400-4060	9	4606-STD	19
1194	11	5104	72	6448	76	8002	65	104PPP	21	2400-4060A	9	4608-STD	19
1197	11	5105	72	6450	82	8200	81	104PTK	21	2400-4064	9	4610-STD	19
1198	11	5106	72	6455	82	8200	93	104PW	21	2400-4064A	9	4612-STD	19
1245	52	5107	72	6458	82	8300	81	105PPB	21	2400-6090	9	6040SQ	76
1260	52	5108	72	6460	82	8300	93	105PPPB	21	2400-6090A	9	6105-T	66
1266	52	5500	57	6600	59	8305	81	105PPW	21	2400-6094	9	6450NS	82
1270	52	5741	10	6617	80	8305	93	105PTK	21	2400-6094A	9	66T	59
1272	52	5742	10	6618	80	8340	81	1100-WM	11	2400-9120	9	7810-23-00	75
1408	10	6000	71	6619	80	8340	93	1194-220V	11	2400-9120A	9	7822-23-00	75
1701	53	6002	71	6620	80	8405	81	1245T	52	2400-9124	9	8001R	65
1750	53	6003	71	6630	80	8406	81	1260B	52	2400-9124A	9	8002R	65
2108	10	6004	71	6631	80	8407	81	1260PS	52	2500-4060	9	8535PKG	67
2110	10	6005	71	6632	80	8410	81	1260PSB	52	2500-4060A	9	8536PKG	67
2134	49	6006	71	6635	80	8412	81	1266B	52	2500-4064	9	9616WL	24
2135	49	6007	71	6640	80	8415	81	1270B	52	2500-4064A	9	9618WL	24
2136	49	6010	76	6650	80	8415	37	1272B	52	2500-6090	9	AAB35	38
2137	33	6020	76	6805	83	8420	81	1272PS	52	2500-6090A	9	AAB35-EXT	38
2137	49	6040	76	6809	83	8426	81	1272PSB	52	2500-6094	9	AAB35R	38
2500	57	6050	77	6810	83	8427	81	1301B	51	2500-6094A	9	AAB45	38
3000	56	6060	77	6811	83	8430	81	1342B	51	2500-9120	9	AAB45-EXT	38
3050	50	6083	71	6812	83	8432	81	1342B-BLK	51	2500-9120A	9	AAB45R	38
3103	7	6085	71	6815	75	8440	81	1342B-BLK	44	2500-9124	9	AAB560	38

PART NUMBER	PAGE	PART NUMBER	PAGE	PART NUMBER	PAGE	PART NUMBER	PAGE	PART NUMBER	PAGE	PART NUMBER	PAGE	PART NUMBER	PAGE
AABS60-EXT	38	BSF46	44	GP104572	42	GSNB0527	100	P2350-6090ST	9	PP6WR	45	TRB0215DF	98
AABS65	38	BSPOLE-12P	109	GP105A60	42	GSNB0527DF	100	P2350-6094GL	9	PP8SQF	45	TRB0221	98
AABS65-EXT	38	BSPOLE-12SM	109	GP105A72	42	GSNB0527DFTP	103	P2350-9120ST	9	PP8WR	45	TRB0221DF	98
AFRG42	48	BSPOLE-15P	109	GP105G60	42	GSNB0527TP	103	P2350-9124GL	9	PR	61	TRB0227	98
AFRG42E	48	BSPOLE-15SM	109	GP105G72	42	GSNB0527WA	101	P2400-4060ST	9	PSCE-PR	55	TRB0227DF	98
AFRG42LED	48	BSPOLE-20P	109	GP105PC72	42	GSNB0527WATP	103	P2400-4064GL	9	RB	61	TRB0308	98
AFRG48	48	BSPOLE-20SM	109	GP105S60	42	GSNB0815WA	101	P2400-6090ST	9	RBO406	92	TRB0308DF	98
ARG	48	BSPOLE-30P	109	GP105572	42	GSNB0821WA	101	P2400-6094GL	9	RB0612	92	TRB0308DFLR	99
AWP	60	BSPOLE-30SM	109	GP106A60	42	GSNB0827WA	101	P2400-9120ST	9	RG	48	TRB0308LR	99
BB48A38	51	CE-PR	55	GP106A72	42	GSNB1015WA	101	P2400-9124GL	9	SBS	109	TRB0315	98
BB60A38	51	CN	44, 60	GP106G60	42	GSNB1021WA	101	P2500-4060ST	9	SCN	44, 66	TRB0315DF	98
BB60G38	50	DBC	60	GP106G72	42	GSNB1027WA	101	P2500-4064GL	9	SGBF	90	TRB0315DFLR	99
BB60G38HH	50	DP35	38	GP106PC72	42	GSNBTK	103	P2500-6090ST	9	SGCF	90	TRB0315LR	99
BB72A38	51	DRYLINE-25	109	GP106S60	42	GSPPAD3	95	P2500-6094GL	9	SGCFA	90	TRB0321	98
BB72G50	50	DRYLINE-50	109	GP106572	42	GSPPAD4	95	P2500-9120ST	9	SGCG	93	TRB0321DF	98
BB72G50HH	50	FGP200	89	GP10A72DM	43	GS-SK2	91	P2500-9124GL	9	SGNC	89	TRB0321DFLR	99
BB72P50	51	FGP200	95	GP10G72DM	43	GS-SK2		PK305010PM	49	SGRD5412PT	88	TRB0321LR	99
BE08IG	106	FGP400GS	95	GP10P72DM	43	GSTCSTRAP	83	PK3505	39	SGRD5416PT	88	TRB0327	98
BE08IGWB	106	FGP401P	95	GP12A72DM	43	GSTNANCH	83	PK3510	39	SGRD548PT	88	TRB0327DF	98
BE08PT	106	FGP401PW	95	GP12G72DM	43	GSTNET30LS	82	PK3511	39	SGRD612PT	87	TRB0327DFLR	99
BE08PTWB	106	FGP401PY	95	GP12P72DM	43	GSTNET30LS	83	PK3515	39	SGRD612SPT	86	TRB0327LR	99
BE08PTWS	106	FGP401S	95	GP205G60	42	GSTNET30LSDC	83	PK3530	39	SGRD618PT	87	TRB0408DFLR	99
BE08SM	106	FGP401SW	95	GP205S60	42	GSTNETAUS	83	PK3531	39	SGRD721PT	87	TRB0408LR	99
BE08SMWB	106	FGP401SY	95	GP7G54	43	GSTNGSERD	83	PK3535	39	SGRD721SPT	86	TRB0415DFLR	99
BE15IGWB	106	FGP402P	95	GP7G60	43	GSTNGSESQ	83	PK3540	39	SGRD7616PT	88	TRB0415LR	99
BE15IN	106	FGP402PW	95	GP8A60DM	43	GSTNPERD	82	PK3545	39	SGRD824I	89	TRB0421DFLR	99
BE15PT	106	FGP402PY	95	GP8G60DM	43	GSTNPERDB	82	PK4530	40	SGRD824PT	87	TRB0421LR	99
BE15PTWB	106	FGP402S	95	GRAPHICS	14	GSTNPESQB3	82	PK4531	40	SGRD824SPT	86	TSC1500	20
BE15PTWS	106	FGP402SW	95	GRAPHICS	19	GSTNPESQG3	82	PK4540	40	SGRD9716PT	88	TSC1500-KP	20
BE15SM	106	FGP402SY	95	GS-200	33	GSTNPOST278	83	PK4541	40	SGRT49PT	88	TSC1500-RB	20
BE15SMWB	106	FGP600GS	95	GS-202	33	GSTNSLV278	83	PK4551	40	SGRT612PT	88	TSC2000	20
BE21IG	106	FGP601P	95	GSBEKIT	106	JJ1	61	PK4560	40	SGRT618PT	88	TSC2000X	20
BE21IGWB	106	FGP601PW	95	GSCASTERKIT	105	JJ5A	61	PK4565	40	SGRT721PT	88	TSC2000XL	20
BE21PT	106	FGP601PY	95	GSCLIPKIT	105	LG100	94	PK4570	40	SGRT824PT	88	TSC-DG	20
BE21PTWB	106	FGP601S	95	GSECAP10KIT	105	LG200	94	PK6005	41	SGSA	90	TSC-ES	20
BE21PTWS	106	FGP601SW	95	GSECAP12KIT	105	LG50	94	PK6010	41	SGSQ612PT	87	TSC-KP	20
BE21SM	106	FGP601SY	95	GSFOOTPADKIT	105	LN-3W	94	PK6015	41	SGSQ612SPT	86	TSC-MC	20
BE21SMWB	106	FGP602P	95	GS-MS3	91	LN-4W	94	PK6025	41	SGSQ618PT	87	TSC-RC	20
BE27IG	106	FGP602PW	95	GSNB0308	100	LN-6W	94	PK6040	41	SGSQ721PT	87	TSC-TS	20
BE27IGWB	106	FGP602PY	95	GSNB0308DF	100	LSC48	45, 54	PK6051	41	SGSQ721SPT	86	VARSIITY	61
BE27PT	106	FGP602S	95	GSNB0308DFLR	102	LSC48	45, 54	PK6091	41	SGSQ824PT	87	VBVB	78
BE27PTWB	106	FGP602SW	95	GSNB0308LR	102	LSC60	45, 54	PKAFR30PM	49	SGSQ824SPT	86	VBVB	78
BE27PTWS	106	FGP602SY	95	GSNB0315	100	LSC72	45, 54	PKAFRG40PMLED	49	SGUA	90	VRK	61
BE27SM	106	FHOG	93	GSNB0315DF	100	LXP4200	48	PKLXP10PS	49	SGUA-STRIKER	90	WCN	44, 60
BE27SMWB	106	FSGII	50	GSNB0315DFLR	102	LXP4200LED	48	PKLXP20PM	49	SGWK	90	WN	44, 60
BNB24P	44	FSSB	92, 94	GSNB0315LR	102	MARKV	60	PKRG20PM	49	SN412-3W	88		
BP4SQ	45	GAW	60	GSNB0321	100	MASTER	61	PLAYMAKER	61	SN416-3W	88		
BP5SQ	45	GGN	60	GSNB0321DF	100	MICRO-Z54	31, 37	PMCEBLK	54	SN48-3W	88		
BP6SQ	45	GN35	38	GSNB0321DFLR	102	MINI-EZ	31, 37	PMCEBRN	54	SN49-3W	89		
BP8SQ	45	GN35R	38	GSNB0321LR	102	NCEGRY-PR	55	PMCEBUR	54	SN612-3W	89		
BR-12	60	GN45	38	GSNB0327	100	ODVB	74	PMCECOL	54	SN616-3W	88		
BR-12	78	GN45-5	38	GSNB0327DF	100	ODVB35	74	PMCEFAST	54	SN618-3O	89		
BR-16	60	GN45-5R	38	GSNB0408DFLR	102	ODVB40SQ	75	PMCEGLD	54	SN618-3W	89		
BR-16	78	GN45R	38	GSNB0408LR	102	ODVBNET	74	PMCEGRY	54	SN716-3W	88		
BRL2	107	GN60	38	GSNB0415DFLR	102	P2300-2030ST	9	PMCEKEL	54	SN721-3O	89		
BRL2-PC	107	GN60R	38	GSNB0415LR	102	P2300-2034GL	9	PMCEMAR	54	SN721-3W	89		
BRL3	107	GNA35	38	GSNB0421DFLR	102	P2300-3040ST	9	PMCENAV	54	SN824-3O	89		
BRL3-PC	107	GNA35R	38	GSNB0421LR	102	P2300-3044GL	9	PMCEORNG	54	SN824-3W	89		
BRL4	107	GNA45	38	GSNB0515	100	P2300-4060ST	9	PMCEPINK	54	SN824-4HEX	89		
BRL4-PC	107	GNA45R	38	GSNB0515DF	100	P2300-4064GL	9	PMCEPUR	54	SN824-4O	89		
BRL5	107	GNB35BRKT	38	GSNB0515DFTP	103	P2300-6090ST	9	PMCERED	54	SN824-4W	89		
BRL5-PC	107	GNB45BRKT	38	GSNB0515TP	103	P2300-6094GL	9	PMCEROY	54	SNAPA	56		
BRM-10D	107	GNB60BRKT	38	GSNB0515WA	101	P2300-9120ST	9	PMCESCAR	54	SNAPB	56		
BRM-10S	107	GNHB	38	GSNB0515WATP	103	P2300-9124GL	9	PMCEYEL	54	SNFIFA	89		
BRM-5D	107	GP104A60	42	GSNB0521	100	P2350-2030ST	9	PP4SQF	45	SP4SQF	90		
BRM-5S	107	GP104A72	42	GSNB0521DF	100	P2350-2034GL	9	PP4SQF	90	SP4WR	90		
BRT-10D	107	GP104G60	42	GSNB0521DFTP	103	P2350-3040ST	9	PP4WR	45	SS16	109		
BRT-10S	107	GP104G72	42	GSNB0521TP	103	P2350-3044GL	9	PP4WR	90	TRB0208	98		
BRT-5D	107	GP104PC72	42	GSNB0521WA	101	P2350-4060ST	9	PP5SQF	45	TRB0208DF	98		
BRT-5S	107	GP104S60	42	GSNB0521WATP	103	P2350-4064GL	9	PP6SQF	45	TRB0215	98		



GARED Holdings
Company



GARED Holdings Company



CONTACT GARED:

GARED NORTH AMERICA Headquarters
CUSTOMER CARE, SALES, ENGINEERING & SHIPPING:
9200 EAST 146TH, NOBLESVILLE, INDIANA 46060 USA



ACM Playgrounds, Inc.
PO Box 179, Buchanan, NY 10511
T. 914-739-6858 F. 914-736-0554
www.acmplaygrounds.com